

İTHAL ÜRÜNLER

2024 - 1
FİYAT LİSTESİ

MARKALARIMIZ



01-03

PORTABIANCO® 05-06

robot  *coupe*® 11-84



CELME[®]
ELECTRIC





FA220

GIDA DİLİMLEME MAKİNASI YATIK TİP

- Aliminyum Gövde
- Yapışmaz paslanmaz bıçak
- Dilimleme Aralığı 0-16 mm
- Güçlü Ürün Tutma Aparatı
- Profesyonel Fan ve Motor



MODEL	BIÇAK ÇAPI	ELEKTRİK BAĞLANTISI	ÖLÇÜLER	FİYAT
FA220	220	220V-1N	380 x 430 x 330	624 €



FA250

GIDA DİLİMLEME MAKİNASI YATIK TİP

- Aliminyum Gövde
- Yapışmaz paslanmaz bıçak
- Dilimleme Aralığı 0-16 mm
- Güçlü Ürün Tutma Aparatı
- Profesyonel Fan ve Motor



MODEL	BIÇAK ÇAPI	ELEKTRİK BAĞLANTISI	ÖLÇÜLER	FİYAT
FA250	250	220V-1N	410 x 510 X 360	713 €



FA275

GIDA DİLİMLEME MAKİNASI YATIK TİP

- Alimunyum Gövde
- Yapışmaz paslanmaz bıçak
- Dilimleme Aralığı 0-16 mm
- Güçlü Ürün Tutma Aparatı
- Profesyonel Fan ve Motor



MODEL	BIÇAK ÇAPI	ELEKTRİK BAĞLANTISI	ÖLÇÜLER	FİYAT
FA275	275	220V-1N	410 x 520 x 370	817 €



FA300

GIDA DİLİMLEME MAKİNASI YATIK TİP

- Alimunyum Gövde
- Yapışmaz paslanmaz bıçak
- Dilimleme Aralığı 0-16 mm
- Güçlü Ürün Tutma Aparatı
- Profesyonel Fan ve Motor



MODEL	BIÇAK ÇAPI	ELEKTRİK BAĞLANTISI	ÖLÇÜLER	FİYAT
FA300	300	220V-1N	420 x 550 x 400	947 €

PORTABIANCO®



BAR BLENDER 1280

- ☞ 1680 Watt güç
- ☞ Hazne kapasitesi: 2,5 Lt.
- ☞ Paslanmaz çelik bıçak
- ☞ Kademeli hız ayarı
- ☞ Buz kırma özelliği
- ☞ Manuel



MODEL	KAPASİTESİ LT.	GÜÇ	ELEKTRİK BAĞLANTISI	ÖLÇÜLER	FİYAT
1280	2,5	1680W	220V-1N	220x 240 x 620	238 €

BAR BLENDER 1280K

- ☞ 1680 Watt güç
- ☞ Hazne kapasitesi: 2,5 Lt.
- ☞ Paslanmaz çelik bıçak
- ☞ Kademeli hız ayarı
- ☞ Buz kırma özelliği
- ☞ Ses önleyici



MODEL	KAPASİTESİ LT.	GÜÇ	ELEKTRİK BAĞLANTISI	ÖLÇÜLER	FİYAT
1280K	2,5	1680W	220V-1N	220x 240 x 620	454 €

PORTABIANCO®

BAR BLENDER 1280C

- ☞ 1600 Watt güç
- ☞ Hazne Kapasitesi: 2,5 Lt.
- ☞ Paslanmaz çelik bıçak
- ☞ Kademeli hız ayarı
- ☞ Buz kırma özelliği
- ☞ Dijital panel



MODEL	KAPASİTESİ LT.	GÜÇ	ELEKTRİK BAĞLANTISI	ÖLÇÜLER	FİYAT
1280C	2,5	1680 W	220V-1N	220x 240 x 580	271 €

PORTABIANCO®

BAR BLENDER 1280CK

- ☞ 1680 Watt güç
- ☞ Hazne kapasitesi: 2,5 Lt.
- ☞ Paslanmaz çelik bıçak
- ☞ Kademeli hız ayarı
- ☞ Buz kırma özelliği
- ☞ Ses önleyici
- ☞ Dijital Panel



MODEL	KAPASİTESİ LT.	GÜÇ	ELEKTRİK BAĞLANTISI	ÖLÇÜLER	FİYAT
1280CK	2,5	1680 W	220V-1N	220x 240 x 620	520 €

HAZNE & KARIŞTIRI ÇUBUK

- ☞ Hazne kapasitesi: 2,5 Lt.

MODEL	KAPASİTESİ LT.	ÖLÇÜLER	FİYAT
HAZ01	2,5	130 x 130 x 330	82 €





robot coupe®

R 402

4,5 L

robot coupe®

KOMBİNELER SEBZE PARÇALAYICI VE DOĞRAYICI



R 201 XL

1.321 €

Asenkron motor	✓
Güç	550 W
Voltaj	Tek fazlı 230 V
Hız	1500 dev/dak.
Darbe	✓
Kesici	Kompozit malzemeden, saplı 2,9 L hazne
Bıçak	Paslanmaz çelik düz bıçak kanatları - Dahil
Sebze doğrayıcı	Yarımay oluk Ø 58 mm silindirik oluk
Çıkartma	Haznenin içinde
Diskler	2 mm dilimleyici, 2 mm rendeleyici - Dahil

R 211 XL

1.460 €

Asenkron motor	✓
Güç	550 W
Voltaj	Tek fazlı 230 V
Hız	1500 dev/dak.
Darbe	✓
Kesici	Kompozit malzemeden, saplı 2,9 L hazne
Bıçak	Paslanmaz çelik düz bıçak kanatları - Dahil
Sebze doğrayıcı	Yarımay oluk Ø 58 mm silindirik oluk
Çıkartma	Devamlı
Diskler	Dahil değil

Modelinizi seçin:

R 201 XL - 7 disk	Fiyat	Ref.
5 disk paketi	449 €	1946
R 201 XL - 6 disk	Fiyat	Ref.
4 disk paketi	348 €	1907
R 201 XL	Fiyat	Ref.
R 201 XL 230V/50/1 - 2 disk	1.321 €	22570

R 211 XL - 5 disk	Fiyat	Ref.
5 disk paketi	449 €	1946
R 211 XL - 4 disk	Fiyat	Ref.
4 disk paketi	348 €	1907
R 211 XL - disksiz	Fiyat	Ref.
R 211 XL 230V/50/1	1.460 €	2129

Tam disk koleksiyonu, sayfa 36



İsteğe bağlı parçaları seçin:



		R 201 XL / R 211 XL
İsteğe bağlı parçalar		Ref.
Kalın dişli bıçak Pastacılık öğütme işlemleri için özel		27138
İnce dişli bıçak Otlar ve Baharatlar için özel		27061
Ek düz bıçak		27055
Meyve/sebze suyu sıkma ve püre kiti		27393
Narenciye sıkacağı aksesuarı		27392

**R 301****1.801 €**

Asenkron motor	✓
Güç	650 W
Voltaj	Tek fazlı 230 V
Hız	1500 dev/dak.
Darbe	✓
Kesici	Kompozit malzemeden 3,7 L hazne
Bıçak	Paslanmaz çelik düz bıçak kanatları - Dahil
Sebze doğrayıcı	1,6 L yarımay oluk Ø 58 mm silindirik oluk
Çıkartma	Devamlı
Diskler	Dahil değil

**R 301 Ultra****2.294 €**

Asenkron motor	✓
Güç	650 W
Voltaj	Tek fazlı 230 V
Hız	1500 dev/dak.
Darbe	✓
Kesici	3,7 L paslanmaz çelik hazne
Bıçak	Paslanmaz çelik düz bıçak kanatları - Dahil
Sebze doğrayıcı	1,6 L yarımay oluk Ø 58 mm silindirik oluk
Çıkartma	Devamlı
Diskler	Dahil değil

Modelinizi seçin:

Kombineleri çalışırken görmek için bu QR-Kodunu tarayın.

R 301 - 5 disk	Fiyat	Ref.
5 disk paketi	449 €	1946
R 301 - 4 disk	Fiyat	Ref.
4 disk paketi	348 €	1907
R 301 - disksiz	Fiyat	Ref.
R 301 230V/50/1	1.801 €	2525

R 301 Ultra - 5 disk	Fiyat	Ref.
5 disk paketi	449 €	1946
R 301 Ultra - 4 disk	Fiyat	Ref.
4 disk paketi	348 €	1907
R 301 Ultra - disksiz	Fiyat	Ref.
R 301 Ultra 230V/50/1	2.294 €	2547

Tam disk koleksiyonu, sayfa 36**İsteğe bağlı parçaları seçin:**

İsteğe bağlı parçalar	R 301	R 301 Ultra
	Ref.	Ref.
Kalın dişli bıçak Pastacılık öğütme işlemleri için özel	27288	27288
İnce dişli bıçak Otlar ve Baharatlar için özel	27287	27287
Ek düz bıçak	27286	27286
Parçalayıcı aksesuarı (hazne, kapak, bıçak)	27272	27278
Meyve/sebze suyu sıkma ve püre kiti	27396	27396
Narenciye sıkacağı aksesuarı	27395	27395

MEYVE/SEBZE SUYU SIKMA VE PÜRE KİTİ

- Mezeler, kuplar, soslar, çorbalar, sorbeler, dondurmalar, smoothie'ler, reçeller, meyve jöleleri için meyve ve sebze suyu çıkarma.
- Pişirilmiş veya yumuşak meyve ve sebzelerin posalı sularının çıkarılması için püre fonksiyonu.
- Tüm narenciye türleri için narenciye sıkacağı fonksiyonu.
- Birçok el aletinin yerini alır:

PÜRE FONKSİYONU

+

NARENCİYE SIKACAĞI FONKSİYONU



Büyük kapasiteli
75x90 mm oluk



Bu fonksiyonu çalışırken
görmek için bu
QR-Kodunu tarayın.



SORBELER İÇİN
AHUDUDU PÜRESİ



KUPLAR İÇİN PÜRE



HİNDİSTAN CEVİZİ SÜTÜ



LİMON SUYU



LİMONLU TART



PORTAKAL SUYU



	Ref.
R201 XL / R211 XL için meyve/sebze suyu sıkma ve püre kiti	27393
R301 / R301 Ultra / R402 için meyve/sebze suyu sıkma ve püre kiti	27396
R 201 XL / R 211 XL için narenciye sıkacağı aksesuarı	27392
R301 / R301 Ultra / R402 için narenciye sıkacağı aksesuarı	27395



R 402

3.621 €

Asenkron motor	✓
Güç	750 W
Voltaj	Tek fazlı 230 V Üç fazlı 400 V
Hız	500-1500 dev/dak. 750-1500 dev/dak.
Darbe	✓
Motor desteği	Metal
Parçalayıcı	4,5 L paslanmaz çelik hazne
Bıçak	Paslanmaz çelik düz bıçak kanatları - Dahil
Sebze doğrayıcı	1,6 L yarımay oluk Ø 58 mm silindirik oluk Paslanmaz çelik hazne
Diskler	Dahil değil

Modelinizi seçin:



Kombineleri çalışırken görmek için bu QR-Kodunu tarayın.

R 402 - 5 disk	Fiyat	Ref.
5 disk paketi	449 €	1946
R 402 - 4 disk	Fiyat	Ref.
4 disk paketi	348 €	1907
R 402 - 6 disk	Fiyat	Ref.
6 disk paketi	656 €	1944
R 402 - disksiz	Fiyat	Ref.
R 402 230V/50/1	3.621 €	2453
R 402 400V/50/3	3.621 €	2433



R 402

İsteğe bağlı parçalar	Ref.
Kalın dişli bıçak Pastacılık öğütme işlemleri için özel	27346
İnce dişli bıçak Otlar ve Baharatlar için özel	27345
Ek düz bıçak	27344
Parçalayıcı aksesuarı (hazne, kapak, bıçak)	27342
Meyve/sebze suyu sıkma ve püre kiti	27396
Narenciye sıkacağı aksesuarı	27395

PÜRE FONKSİYONU

MODELLER R 502, R 652 V.V.

• **Hacim ve hız**

2 dakika içinde 10 kg'a kadar taze ve lezzetli püre yapılabilir.

• **Ergonomi**

Büyük ergonomik oluk, elle işlemeyi sınırlandırırken patateslerin sürekli yüklenmesini mümkün kılar.

• **Çok yönlülük**

Sebze doğrayıcınızda 50'nin üstünde meyve ve sebze doğrama şekline ek olarak püre fonksiyonundan yararlanın.

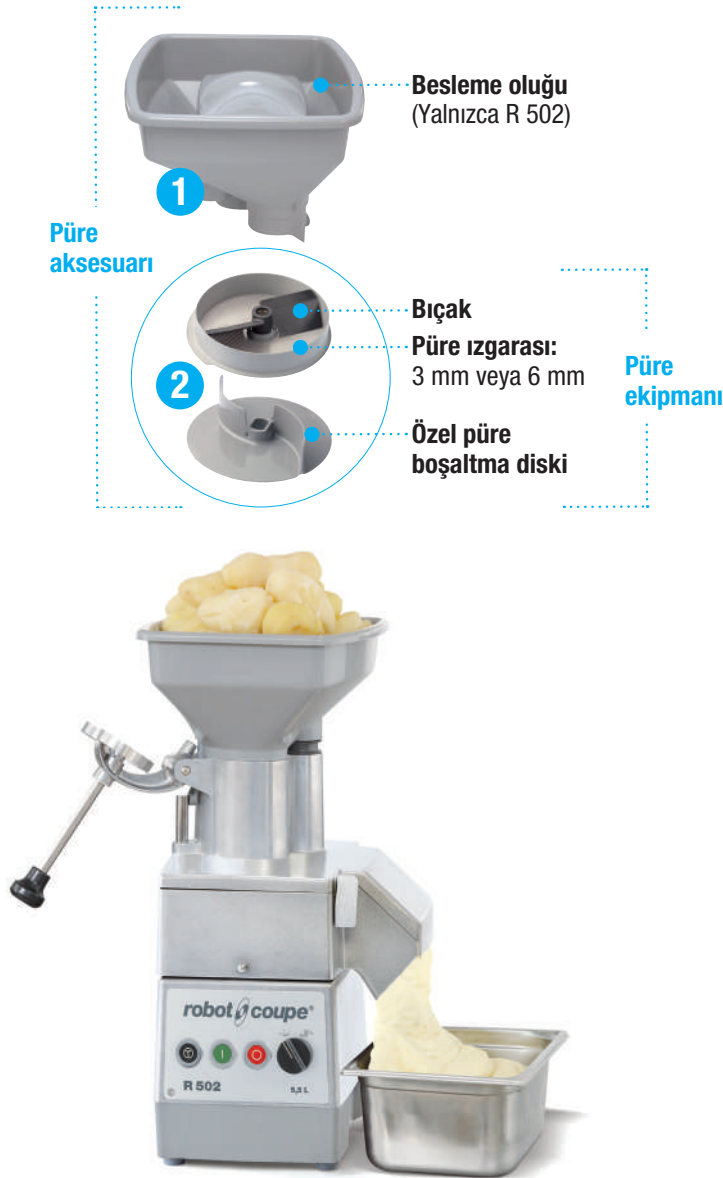

Püre aksesuarı aşağıdakilerden oluşur:

- Patateslerin yüklenmesini kolaylaştırmak için besleme oluğu (sadece R 502 için)
- bıçak
- Ø 3 mm veya 6 mm özel ızgara
- özel püre tahliye diskisi

		Ref.
Ø 3 mm püre aksesuarı (R 502)	1 + 2	28207
Ø 3 mm püre ekipmanı	1	28208
Ø 6 mm püre aksesuarı (R 502)	1 + 2	28209
Ø 6 mm püre ekipmanı	1	28210

**R 502****4.292 €****R 502 V.V.****4.654 €**

Motor	Asenkron	Asenkron
Güç	900 W	1500 W
Voltaj	Üç fazlı 400 V	Tek fazlı 230 V
Hız	750 dev/dak. - 1500 dev/dak.	Kesicide 300 ila 3500 dev/dak. sebze doğrayıcıda 300 ila 1000 dev/dak.

Darbe	✓	✓
Motor desteği	Metal	Metal
Parçalayıcı	5,9 L paslanmaz çelik hazne	5,9 L paslanmaz çelik hazne
Sıyırma spatulası	✓	✓

Bıçak	Paslanmaz çelik düz bıçak kanatları - Dahil Bıçak temizleme aracı - Dahil	Paslanmaz çelik düz bıçak kanatları - Dahil Bıçak temizleme aracı - Dahil
Sebze doğrayıcı	2,2 L yarımay oluk Ø 58 mm ve Ø 39 mm silindirik oluk, Exactitube itme kolu - Dahil	2,2 L yarımay oluk Ø 58 mm ve Ø 39 mm silindirik oluk, Exactitube itme kolu - Dahil

D-Clean Kit	Dahil	Dahil
Diskler	Dahil değil	Dahil değil

Modelinizi seçin:

R 502 Restoranlar	Fiyat	Ref.
R 502 400V/50/3	4.292 €	2382
8 disk paketi	1.341 €	1933
R 502 Kurumlar		Ref.
12 disk paketi	2.009 €	1942
R 502 Restoranlar		Ref.
7 disk paketi	1.210 €	1943
R 502 - disksiz		Ref.
R 502 400V/50/3	4.292 €	2382

R 502 V.V. Restoranlar	Fiyat	Ref.
R 502 V.V. 230V/50/1	4.654 €	2390
8 disk paketi	1.341 €	1933
R 502 V.V. Kurumlar		Ref.
12 disk paketi	2.009 €	1942
R 502 V.V. Restoranlar		Ref.
7 disk paketi	1.210 €	1943
R 502 V.V. - disksiz		Ref.
R 502 V.V. 230V/50/1	4.654 €	2390

Tam disk koleksiyonu, sayfa 36**R 502 / R 502 V.V.****İsteğe bağlı parçaları seçin:**

İsteğe bağlı parçalar	Ref.
Kalın dişli bıçak Pastacılık öğütme işlemleri için özel	27305
İnce dişli bıçak Otlar ve Baharatlar için özel	27304
Ek düz bıçak	27303
Parçalayıcı aksesuarı (hazne, kapak, bıçak)	27320
Bıçak temizleme aracı	49258
Narenciye sıkacağı aksesuarı	27395

KOMBİNELER SEBZE PARÇALAYICI VE DOĞRAYICI

R 752 V.V. KOMBİNELER

- Daha fazla çalışma kapasitesi sayesinde çok yönlü, kompakt ve her zaman daha verimli
- Daha rahat kullanım için zamanlayıcı
- Her zaman profesyonellerin ihtiyaçlarına daha uygun hale getirilen yeni aksesuarlar!

Her boyutta meyve ve sebze uyum sağlayacak şekilde ayarlanabilir oluk!



- Çalışma konforu
- MSD'lerin önlenmesi
- Zorluğun azaltılması



Ekstra Büyük oluk:
15 domatese veya
1 bütün lahanaya kadar.



Silindirik oluk
Ø 58 mm : Uzun
ürünlerin eşit kesimi.



Exactitube itme kolu:
Ø 39 mm Exactitube itme kolu
silindirik oluk; biber, salatalık
turşusu, kuru sosis, kuşkonmaz,
taze soğan, muz, çilek, üzüm
gibi küçük meyve ve sebzelerin
kesimi.

İNOVASYON

Dikkat çekici ergonomi:
Destekli hareketli kol
= kullanıcı daha az çaba
sarf eder.

Zamanlayıcı:
Tarifleri yaparken daha
fazla çalışma konforu,
hassasiyet ve düzenlilik.

Easy Guide

Motor gücü:
En zorlu hazırlıkların
yapılmasına olanak tanır.



**Tamamen paslanmaz çelik
düz bıçakla teslim edilir:**
2 çıkarılabilir ve ayarlanabilir
bıçak kanadı.



İsteğe bağlı olarak
50'den fazla disk serisi.

Yandan çıkartma:
yerden tasarruf ve kullanım
rahatlığı.

Kapak:
Üretim sırasında sıvı veya malzeme
ekleme imkanı.



Sıyırma kolu:
Köşelerde zorlanmadan
haznenin kapağı ve
kenarları kolayca sıyırılır.

**Ergonomik saplı 7,5 L
büyük kapasiteli hazne:**
Çalışılan miktarı artırarak
zaman kazanılır.*

R 752 V.V. için isteğe bağlı parçalar	Ref.
Paslanmaz çelik kalın dişli bıçak Pastacılık öğütme işlemleri için özel	27308
Paslanmaz çelikten ince dişli bıçak Otlar ve Baharatlar için özel	27307
Ek düz paslanmaz çelik bıçak	27306
Parçalayıcı aksesuarı (hazne, kapak, bıçak)	27318
Alt kalın dişli bıçak kanadı	49162
Üst kalın dişli bıçak kanadı	49163
Alt ince dişli bıçak kanadı	49164
Üst ince dişli bıçak kanadı	49165
Alt düz bıçak kanadı	49160
Üst düz bıçak kanadı	49161
3 mm püre ekipmanı	28208
6 mm püre ekipmanı	28210
Motor mili fırçası	49257

* R 502 / R 502 V.V. için 5,9 L hazne ve R 752 V.V. için 7,5 L hazne.



R 752 V.V. 5.739 €

Motor	Asenkron
Güç	1500 W
Voltaj	Tek fazlı 230 V
Hız	Kesicide 300 ila 3500 dev/dak. sebze doğrayıcıda 300 ila 1000 dev/dak.
Darbe	✓
Motor desteği	Metal
Parçalayıcı	7,5 L paslanmaz çelik hazne
Sıyırma spatulası	✓
Bıçak	Tamamen paslanmaz çelik, çıkarılabilir ve ayarlanabilir düz bıçak kanatları - Dahil
Aksesuarlar	Motor mili fırçası - Dahil
Sebze doğrayıcı	4,4 L yarımay oluk Ø 58 mm ve Ø 39 mm silindirik oluk, Exactitube itme kolu - Dahil
D-Clean Kit	Dahil
Diskler	Dahil değil

Modelinizi seçin:

R 752 V.V. Restoranlar	Fiyat	Ref.
8 disk paketi	1.341 €	1933
R 752 V.V. Kurumlar	Fiyat	Ref.
12 disk paketi	2.009 €	1942
R 752 V.V. Restoranlar	Fiyat	Ref.
7 disk paketi	1.210 €	1943
R 752 V.V. - disksiz	Fiyat	Ref.
R 752 V.V. 230V/50/1	5.739 €	2115

← Karşı sayfadan isteğe bağlı parçalarınızı seçin:



Tam disk koleksiyonu, sayfa 36



DİSK SEÇİMİ



ESSENTIAL
Serisi 1-4



ESSENTIAL
Serisi 1-4



EXPERT
Serisi 5-7



EXPERT
Serisi 5-7

R 201 XL R 211 XL R 301 R 301 Ultra	R 402	CL 30 Bistro
CL 20		

DİSKLER

R 502 R 652 V.V.	CL 50/CL 50 Ultra CL 52/CL 55 CL 60	CL 50 Gourmet
---------------------	---	------------------

DİLİMLEYİCİLER



			0,6 mm bademler	28166	28166
			0,8 mm	28069	28069
27051	27051		1 mm	28062	28062
27555	27555		2 mm	28063	28063
27086	27086		3 mm	28064	28064
27566	27566		4 mm	28004	28004
27087	27087		5 mm	28065	28065
27786	27786		6 mm	28196	28196
			8 mm	28066	28066
			10 mm	28067	28067
			14 mm	28068	28068
			4 mm pişmiş patates	27244	27244
			6 mm pişmiş patates	27245	27245

DALGALI



27621	27621		2 mm	27068	27068
			3 mm	27069	27069
			5 mm	27070	27070

RENDELEYİCİLER



27588	27588	27148	1,5 mm	28056	28056
27577	27577	27149	2 mm	28057	28057
27511	27511	27150	3 mm	28058	28058
			4 mm	28073	28073
			5 mm	28059	28059
27046	27046		6 mm		
			7 mm	28016	28016
27632	27632		9 mm	28060	28060
27764	27764		Parmesan	28061	28061
27191	27191		Rösti tipi patates	27164	27164
			Çiğ patates	27219	27219
27078	27078		0,7 mm yabancurubu		
27079	27079		1 mm yabancurubu	28055	28055
27130	27130		1,3 mm yabancurubu		

ŞERİT/JÜLYEN



			1,8 mm (tagliatelle)	28172	28172
			1 x 26 soğan/lahana	28153	28153
27080	27080		2 x 4 mm	27072	27072
27081	27081		2 x 6 mm	27066	27066
			2 x 8 mm	27067	27067
			2 x 10 mm (tagliatelle)	28173	28173
27599	27599		2 x 2 mm	28051	28051
			2,5 x 2,5 mm	28195	28195
			3 x 3 mm	28101	28101
27047	27047		4 x 4 mm	28052	28052
27610	27610		6 x 6 mm	28053	28053
27048	27048		8 x 8 mm	28054	28054



ESSENTIAL
Serisi 1-4

R 402

CL 30 Bistro



EXPERT
Serisi 5-7

R 502
R 652 V.V.

CL 50/CL 50 Ultra
CL 52/CL 55
CL 60



EXPERT
Serisi 5-7

CL 50
Gourmet

DİSKLER

KÜP KESİM EKİPMANLARI



IZGARA + DİLİMLEYİCİ

■ 27113	5 x 5 x 5 mm	■ 28110	■ 28110
■ 27114	8 x 8 x 8 mm	■ 28111	■ 28111
■ 27298	10 x 10 x 10 mm	■ 28112	■ 28112
	12 x 12 x 12 mm	■ 28197	
	14 x 14 x 5 mm (mozzarella)	■ 28181	■ 28181
	14 x 14 x 10 mm	■ 28179	■ 28179
	14 x 14 x 14 mm	■ 28113	
	20 x 20 x 20 mm	■ 28114	
	25 x 25 x 25 mm	■ 28115	
	50 x 70 x 25 mm (salata)	■ 28180	

PARMAK PATATES



▲ 27116	8 x 8 mm	▲ 28134	▲ 28134
	8 x 16 mm	▲ 28159	▲ 28159
▲ 27117	10 x 10 mm	▲ 28135	▲ 28135
	10 x 16 mm	▲ 28158	▲ 28158

BURNUAZ



	2 x 2 x 2 mm		28174
	3 x 3 x 3 mm		28175
	4 x 4 x 4 mm		28176

WAFFLE



	2 mm		28198
	3 mm		28199
	4 mm		28177
	6 mm		28178

■ KÜP KESİM ekipmanının parçaları: 1 küp kesim ızgarası + 1 dilimleme diski.

▲ PARMAK PATATES ekipmanının parçaları: 1 parmak patates ızgarası + 1 özel parmak patates dilimleme diski.

AKSESUARLAR

DUVARA MONTE AKSESUAR ASKISI: BIÇAK ve 8 DİSK
> R 201 XL'den R 402'ye



107810

DUVARA MONTE 4 PASLANMAZ ÇELİK ÇUBUKLU DİSK ASKISI
> 16 küçük disk veya 8 büyük disk



107812

DİSK DOLABI:
R 502'den R 652 V.V.'ye > CL 50'den CL 60'ye



27258

PASLANMAZ ÇELİK DUVAR
DİSK TUTUCU



101230

D-CLEAN KİTİ: KÜP KESİM IZGARASI
TEMİZLEME ALETİ (5,8 veya 10 mm)



39881

DİSK KORUMA
> R 502'den R 652 V.V.'ye > CL 50'den CL 60'ye



39726



EN BÜYÜK KESİM ÇEŞİTLİLİĞİ

DİLİMLEYİCİLER

Expert : CL 50, CL 50 Ultra, CL 50 Gourmet, CL 52, CL 55, CL 60, R 502 ve R 652 V.V.

Essential : CL 20, CL 30 Bistro, R 201 XL, R 211 XL, R 301, R 301 Ultra, R 402

0,6 mm'den 3 mm'ye veya 3 mm'den 14 mm'ye

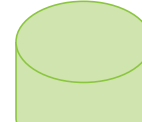
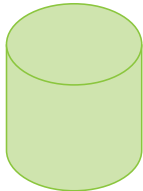
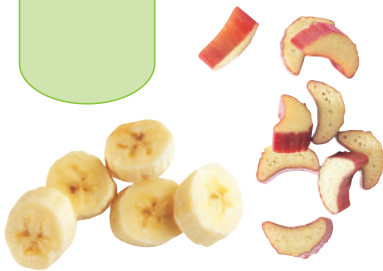
**0,6 mm bademler**
Ref. 28166**0,8 mm**
Ref. 28069**1 mm**
Ref. 28062
Ref. 27051**2 mm**
Ref. 28063
Ref. 27555**3 mm**
Ref. 28064
Ref. 27086**4 mm**
Ref. 28004
Ref. 27566**5 mm**
Ref. 28065
Ref. 27087**6 mm**
Ref. 28196
Ref. 27786**8 mm**
Ref. 28066**10 mm**
Ref. 28067**14 mm***
Ref. 28068**4 mm pişmiş patates**
Ref. 27244**6 mm pişmiş patates**
Ref. 27245



ŞERİT - JÜLYEN

Expert : CL 50, CL 50 Ultra, CL 50 Gourmet, CL 52, CL 55, CL 60, R 502 ve R 652 V.V.

Essential : CL 20, CL 30 Bistro, R 201 XL, R 211 XL, R 301, R 301 Ultra, R 402



**1 x 8 mm
tagliatelle**
Ref. 28172



**1 x 26 mm
soğan ve lahana**
Ref. 28153



2 x 4 mm
Ref. 27072
Ref. 27080



2 x 6 mm
Ref. 27066
Ref. 27081

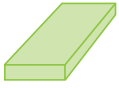

2 x 8 mm
Ref. 27067

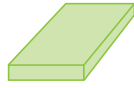

**2 x 10 mm
Tagliatelles**
Ref. 28173



2 x 2 mm
Ref. 28051
Ref. 27599



2,5 x 2,5 mm
Ref. 28195



3 x 3 mm
Ref. 28101



4 x 4 mm
Ref. 28052
Ref. 27047



6 x 6 mm
Ref. 28053
Ref. 27610



8 x 8 mm
Ref. 28054
Ref. 27048



PARMAK PATATES

Expert : CL 50, CL 50 Ultra, CL 50 Gourmet, CL 52, CL 55, CL 60, R 502 ve R 652 V.V.

Essential : CL 30 Bistro, R 402

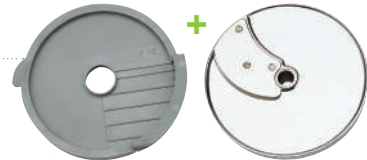

1 x 8 mm'den 8 x 8 mm'ye

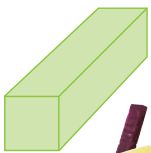

8 x 8 mm
Ref. 28134
Ref. 27116



Mor
patates

Yeşil semboller 1:1 ölçөгindedir

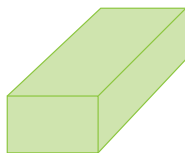

8 x 16 mm
Ref. 28159



Tatlı patates



10 x 10 mm
Ref. 28135
Ref. 27117



Elma

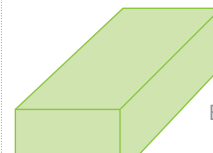

10 x 16 mm
Ref. 28158

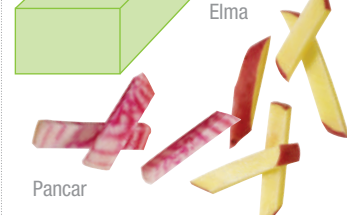

Pancar



EN BÜYÜK KESİM ÇEŞİTLİLİĞİ

























RENDELEYİCİLER



Expert : CL 50, CL 50 Ultra, CL 50 Gourmet, CL 52, CL 55, CL 60, R 502 ve R 652 V.V.

Essential : CL 20, CL 30 Bistro, R 201 XL, R 211 XL, R 301, R 301 Ultra, R 402

Essential : Özel CL 30 Bistro

 <p>1,5 mm Ref. 28056 Ref. 27588* Ref. 27148</p> 	 <p>2 mm Ref. 28057 Ref. 27577* Ref. 27149</p> 	 <p>3 mm Ref. 28058 Ref. 27511* Ref. 27150</p> 	 <p>4 mm Ref. 28073</p> 
 <p>5 mm Ref. 28059</p> 	 <p>6 mm Ref. 27046</p> 	 <p>7 mm Ref. 28016</p> 	 <p>9 mm Ref. 28060 Ref. 27632</p> 
 <p>Parmesan Ref. 28061 Ref. 27764</p> 	 <p>Rösti tipi patates Ref. 27164 Ref. 27191</p> 	 <p>Çiğ patates Ref. 27219</p> 	 <p>1 mm yabanturbu Ref. 28055 Ref. 27078 0,7 mm Ref. 27079 1 mm Ref. 27130 1,3 mm</p> 

DALGALI

Expert : CL 50, CL 50 Ultra, CL 50 Gourmet, CL 52, CL 55, CL 60, R 502 ve R 652 V.V.

Essential : CL 20, CL 30 Bistro, R 201 XL, R 211 XL, R 301, R 301 Ultra, R 402

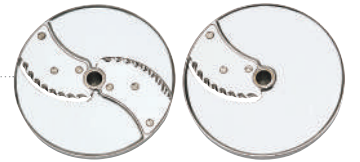

 <p>2 mm Ref. 27068 Ref. 27621</p> 	 <p>3 mm Ref. 27069</p> 	 <p>5 mm Ref. 27070</p> 
--	--	---

Yeşil semboller 1:1 ölçөгündedir

* CL 30 Bistro hariç



KÜP KESİM EKİPMANLARI

Expert : CL 50, CL 50 Ultra, CL 50 Gourmet, CL 52, CL 55, CL 60, R 502 ve R 652 V.V.

Essential : CL 30 Bistro, R 402

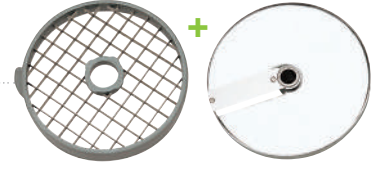

5x5x5 mm
Ref. 28110

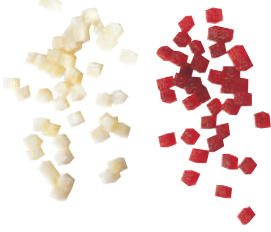

8x8x8 mm
Ref. 280111
Ref. 27113

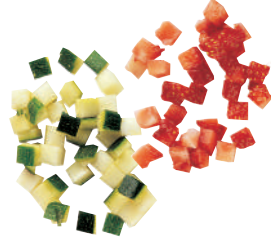

10x10x10 mm
Ref. 28112
Ref. 27114



12x12x12 mm
Ref. 28197
Ref. 27298



14x14x5 mm
Ref. 28181



14x14x10 mm*
Ref. 28179

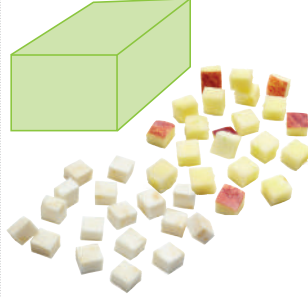

14x14x14 mm*
Ref. 28113

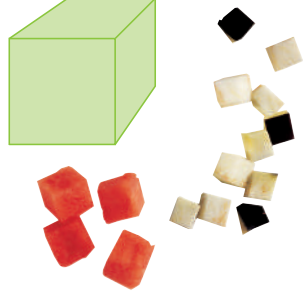

20x20x20 mm*
Ref. 28114

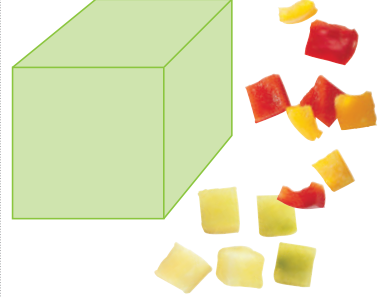

25x25x25 mm*
Ref. 28115



50x70x25 mm*
Salatalar
Ref. 28180



D-CLEAN KIT



Çevrilebilir ızgara desteği

- R 402 - CL 30 Bistro tek taraflı Essential ızgara
- CL 50 - CL 60 ve R 502 - R 652 tek taraflı Expert ızgara



Küp kesim ızgara temizleme aleti

5 mm, 8 mm ve 10 mm



Sıyrıcı alet

Ref.

Küp kesim ızgara temizleme aleti

39881



EŞSİZ KESİMLER

BURNUAZ

CL 50 Gourmet



 **2x2x2 mm**
Ref. 28174

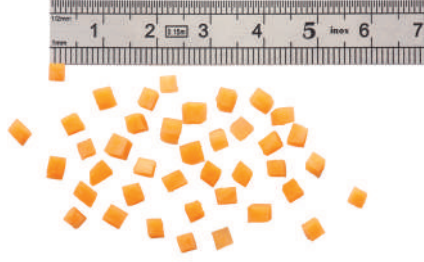

 **3x3x3 mm**
Ref. 28175

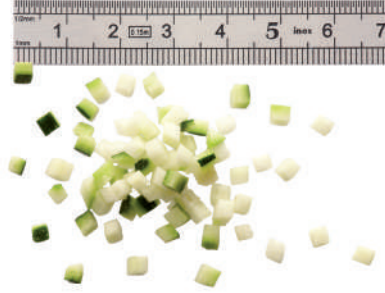

 **4x4x4 mm**
Ref. 28176

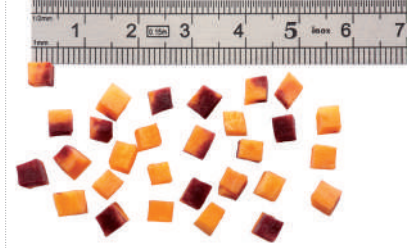

WAFFLE KESİM

CL 50 Gourmet

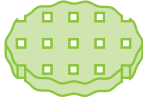

2 mm
Ref. 28198

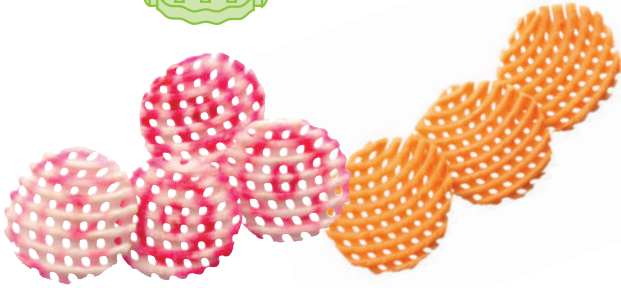

3 mm
Ref. 28199



4 mm
Ref. 28177

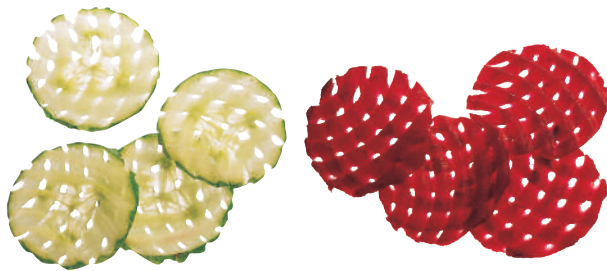

6 mm
Ref. 28178

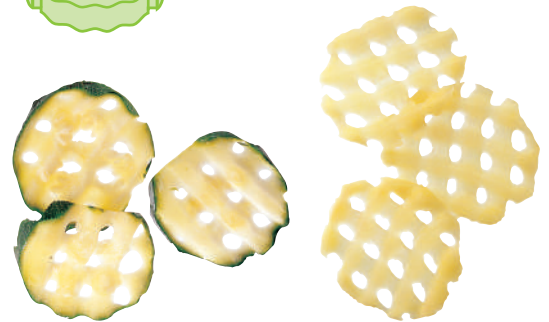

Yeşil semboller 1:1 ölçeğindedir

ESSENTIAL Serisi 1-4

4 DİSK

Dilimleyiciler



2 mm

Elma, kırmızı lahana, soğan, havuç...



4 mm

Limon, biber, pırasa, tatlı patates...

Rendeleyiciler



2 mm

Yeşil papaya, kabak, çiğ pancar, havuç...

Jülyen



4 x 4 mm

Havuç, turp, elma...

Ref.

R 201 XL, R 211 XL, R 301, R 301 Ultra, R 402. CL 20 ve CL 30 Bistro modelleri için 4 disk paketi

1907

5 DİSK

Dilimleyiciler



2 mm

Elma, kırmızı lahana, soğan, havuç...



4 mm

Limon, biber, pırasa, tatlı patates...

Rendeleyiciler



2 mm

Yeşil papaya, kabak, çiğ pancar, havuç...

Jülyen



4 x 4 mm

Armut, şalgam, havuç, kabak...



8 x 8 mm

Kereviz, tatlı patates, turp, kırmızı pancar...

Ref.

R 201 XL, R 211 XL, R 301, R 301 Ultra, R 402. CL 20 ve CL 30 Bistro modelleri için 5 disk paketi

1946

7 DİSK

Dilimleyiciler



2 mm

Elma, kırmızı lahana, soğan, havuç...



4 mm

Limon, biber, pırasa, tatlı patates...

Rendeleyiciler



2 mm

Yeşil papaya, kabak, çiğ pancar, havuç...

Jülyen



4 x 4 mm

Armut, şalgam, havuç, kabak...



8 x 8 mm

Kereviz, tatlı patates, turp, kırmızı pancar...

Küp



10 x 10 x 10 mm
Elma, domates, kabak,
biber.

Ref.

R 402 için 7'li paket

1943

ESSENTIAL Serisi 1-4

6 DİSK

Dilimleyiciler



2 mm

Elma, kırmızı lahana, soğan, havuç...



4 mm

Limon, biber, pırasa, tatlı patates...

Rendeleyiciler



2 mm

Yeşil papaya, kabak, çiğ pancar, havuç...

Jülyen



4 x 4 mm

Havuç, turp, elma...

Küp

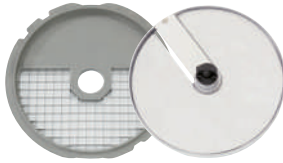

10 x 10 x 10 mm

Elma, domates, kabak, biber.

	Ref.
CL 30 Bistro için 6'lü paket	1945

8 DİSK

Dilimleyiciler



2 mm

Elma, kırmızı lahana, soğan, havuç...



4 mm

Limon, biber, pırasa, tatlı patates...

Rendeleyiciler



2 mm

Yeşil papaya, kabak, çiğ pancar, havuç...

Jülyen



2 x 2 mm

Armut, şalgam, havuç, kabak...

Jülyen



2 x 4 mm

Armut, şalgam, havuç, kabak...



4 x 4 mm

Kereviz, tatlı patates, turp, kırmızı pancar...

Küp

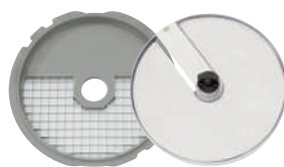

10 x 10 x 10 mm
Elma, domates, kabak, biber.

	Ref.
CL 30 Bistro için 8'lü paket	1909

EXPERT Serisi 5-7

RESTORANLAR

Dilimleyiciler



2 mm

Elma, kırmızı lahana, soğan, havuç...



5 mm

Limon, biber, pırasa, tatlı patates...

Rendeleyiciler

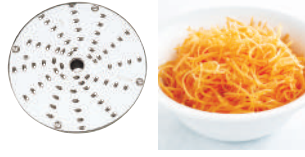

2 mm

Yeşil papaya, kabak, çiğ pancar, havuç...

Jülyen



3 x 3 mm

Armut, şalgam, havuç, kabak...



4 x 4 mm

Kereviz, tatlı patates, turp, kırmızı pancar...

Parmak patates

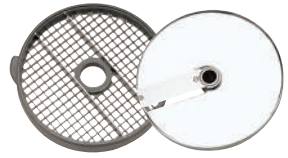

10 x 10 x 10 mm
Elma, domates, kabak,
biber.

	Ref.
R 502, R 652 V.V., CL 50, CL 50 Ultra, CL 52, CL 55 ve CL 60 modelleri için 7 disk paketi	1943

RESTORANLAR

Dilimleyiciler



2 mm

Elma, kırmızı lahana, soğan, havuç...



5 mm

Limon, biber, pırasa, tatlı patates...

Rendeleyiciler

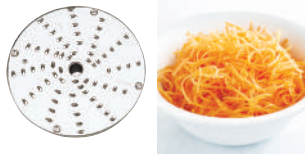

2 mm

Yeşil papaya, kabak, çiğ pancar, havuç...

Jülyen



3 x 3 mm

Armut, şalgam, havuç, kabak...

Parmak patates



10 x 10 x 10 mm
Patates, şalgam, kereviz,
kabak, tatlı patates, ya-
bani havuç.

Küp

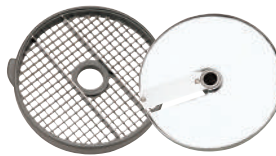

10 x 10 x 10 mm
Elma, domates, kabak,
biber.

	Ref.
R 502, ve R 652 V.V. modelleri için 8 disk paketi	1933

EXPERT Serisi 5-7

RESTORANLAR

Dilimleyiciler



2 mm

Elma, kırmızı lahana, soğan, havuç...



5 mm

Limon, biber, pırasa, tatlı patates...

Rendeleyiciler



2 mm

Yeşil papaya, kabak, çiğ pancar, havuç...



3 mm

Yeşil elma, beyaz lahana, pişmiş pancar...

Küp

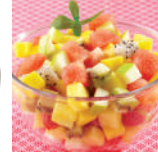
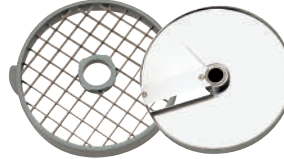
10 x 10 x 10 mm
Elma, domates, kabak,
biber.20 x 20 x 20 mm
Karpuz, havuç, salatalık,
kereviz kökü...

Duvar Tipi Disk Askısı

CL 50, CL 50 Ultra, CL 52, CL 55 ve CL 60 modelleri için 8 disk paketi

Ref.

1927

RESTORANLAR

Dilimleyiciler



2 mm

Elma, kırmızı lahana, soğan, havuç...



5 mm

Limon, biber, pırasa, tatlı patates...

Rendeleyiciler



2 mm

Yeşil papaya, kabak, çiğ pancar, havuç...



3 mm

Yeşil elma, beyaz lahana, pişmiş pancar...

Jülyen



3 x 3 mm

Armut, şalgam, havuç, kabak...



4 x 4 mm

Kereviz, tatlı patates, turp, kırmızı pancar...

Parmak patates

10 x 10 x 10 mm
Patates, şalgam, kereviz,
kabak, tatlı patates, ya-
bani havuç.

Küp

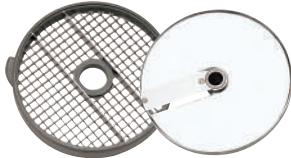
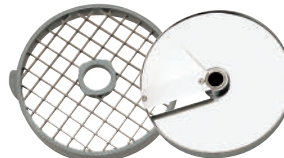
10 x 10 x 10 mm
Elma, domates, kabak,
biber.20 x 20 x 20 mm
Karpuz, havuç, salatalık,
kereviz kökü...

Duvar Tipi Disk Askısı

R 502, R 652 V.V., CL 50, CL 50 Ultra, CL 52, CL 55 ve CL 60 modelleri için 12 disk paketi

Ref.

1942

16 DISKLI MULTICUT PAKETİ

HER ŞEKİLDE VE BOYUTTA MEYVE VE SEBZELER

Büyük yemek sektörlerinde çalışan aşçılar, Beslenme ihtiyacının sürekli olarak arttığı bu dönemde daha fazla meyve ve taze sebze sunmak için çözüm arıyor.

Bu sayede okul yemekhaneleri, şirket kafeteryaları ve sağlık kuruluşlarında sunulan yemeklerin besin kalitesinin artırılması hedeflenmektedir.

Yaratıcı ve orijinal kesimler elde etmek ve taze meyve ve sebzeleri daha çekici bir şekilde sunmak için aşçılara yönelik mükemmel bir fırsattır.

Robot-Coupe, 16 diskten oluşan en yeni Hazırlık İstasyonu Çözüm Paketi ile kendini yeniliyor.

Dilimleyiciler



1 mm

Elma, kırmızı lahana, soğan, havuç...



2 mm

Limon, biber, pırasa, tatlı patates...



4 mm

Kivi, domates, mantar, hindiba...



Rendeleyiciler



1.5 mm

Yeşil papaya, kabak, çiğ pancar, havuç...



3 mm

Yeşil elma, beyaz lahana, pişmiş pancar, kereviz kökü...



Küp

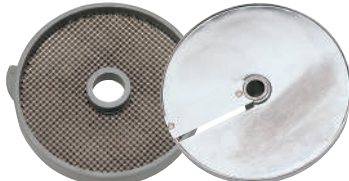

5 x 5 x 5 mm

Kavun, salatalık, havuç, pişmiş pancar...

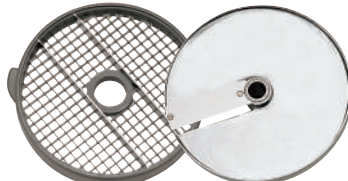

10 x 10 x 10 mm

Elma, domates, kabak, biber...

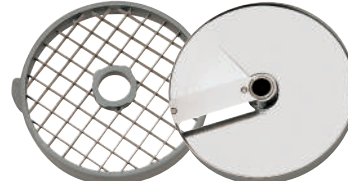

20 x 20 x 20 mm

Karpuz, havuç, salatalık, kereviz kökü...



Parmak patates

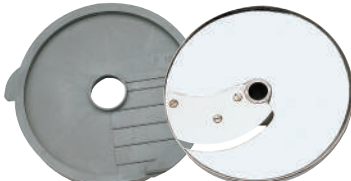

10 x 10 mm

Patates, şalgam, kereviz, kabak, tatlı patates, yabani havuç.

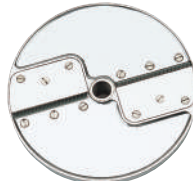

2,5 x 2,5 mm

Armut, şalgam, havuç, kabak...



2 x 10 mm

Elma, havuç, turp, çiğ pancar...



4 x 4 mm

Havuç, salatalık, kereviz, tatlı patates, turp, kırmızı pancar...



Duvara monte 4 disk askısı

16 disk için



D-Clean kiti

Izgara temizleme aleti



Ref.

16 diskli MultiCut paketi

2022

SEBZE DOĞRAMA



PÜRE FONKSİYONU

CL 50, CL 52, CL 55, CL 60

• Hacim ve hız

2 dakika içinde 10 kg'a kadar taze ve lezzetli püre yapılabilir.

• Ergonomi

Büyük ergonomik oluk, elle işlemeyi sınırlandırırken patateslerin sürekli yüklenmesini mümkün kılar.

• Çok yönlülük

Sebze doğrayıcınızda 50'nin üstünde meyve ve sebze doğrama şekline ek olarak püre fonksiyonundan yararlanın.



Besleme oluğu
(yalnızca CL 50 ve CL 50 Ultra için)

Püre aksesuarı



Bıçak
Püre ızgarası:
3 mm veya 6 mm

Püre ekipmanı

Özel püre boşaltma disk



Püre fonksiyonunu çalışırken görmek için bu QR-Kodunu tarayın.

Püre aksesuarı aşağıdakilerden oluşur:

- Patateslerin yüklenmesini kolaylaştırmak için besleme oluğu (sadece CL 50 ve CL 50 Ultra için)
- bıçak
- Ø 3 mm veya 6 mm özel ızgara
- özel püre tahliye disk

		Ref.
Ø 3 mm püre aksesuarı (CL 50 ve CL 50 Ultra)	1 + 2	28207
Ø 3 mm püre ekipmanı	1	28208
Ø 6 mm püre aksesuarı (CL 50 ve CL 50 Ultra)	1 + 2	28209
Ø 6 mm püre ekipmanı	1	28210

SET ÜSTÜ SEBZE DOĞRAMA

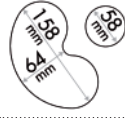

104 cm² yüzey

"Tüm disk paketlerini sayfa 43'da keşfedin!"

CL 20

1.413 €

Asenkron motor



Güç

400 W

Voltaj

Tek fazlı 230 V

Hız

1500 dev/dak.

Oluklar

Yarımay oluk
Ø 58 mm silindirik oluk

Kapak ve hazne

Kompozit malzeme

Motor bloku

Kompozit malzeme

Diskler

Dahil değil

Modelinizi seçin:

CL 20 - 5 disk	Fiyat	Ref.
5 disk paketi	449 €	1946
CL 20 - 4 disk	Fiyat	Ref.
4 disk paketi	348 €	1907
CL 20	Fiyat	Ref.
CL 20 230V/50/1	1.413 €	22394

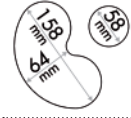

104 cm² yüzey

"Tüm disk paketlerini sayfa 43'da keşfedin!"

CL 30 Bistro

1.571 €



500 W

Tek fazlı 230 V

500 dev/dak.

Yarımay oluk
Ø 58 mm silindirik oluk

Kompozit malzeme

Kompozit malzeme

Dahil değil

CL 30 Bistro - 5 disk	Fiyat	Ref.
5 disk paketi	449 €	1946
CL 30 Bistro - 4 disk	Fiyat	Ref.
4 disk paketi	348 €	1907
CL 30 Bistro - 6 disk	Fiyat	Ref.
6 disk paketi	656 €	1945
CL 30 Bistro - 8 disk	Fiyat	Ref.
8 disk paketi	856 €	1909
CL 30 Bistro - disksiz	Fiyat	Ref.
CL 30 Bistro 230V/50/1	1.571 €	24432

Tam disk koleksiyonu, sayfa 36





139 cm² yüzey

"Tüm disk paketlerini sayfa 45'da keşfedin!"

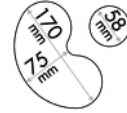

139 cm² yüzey

"Tüm disk paketlerini sayfa 45'da keşfedin!"

CL 50 - 1V 2.339 €

Asenkron motor	✓
Güç	550 W
Voltaj	Tek fazlı 230 V
Hız	375 dev/dak.
Oluklar	2,2 L yarımay oluk Ø 58 mm ve Ø 39 mm silindirik oluk, Exactitube itici aparatı - Dahil
Kapak ve hazne	Metal
Motor bloku	Kompozit malzeme
Diskler	Dahil değil

Modelinizi seçin:

CL 50 Restoranlar	Fiyat	Ref.
8 disk paketi	1.215 €	1927
CL 50 Kurumlar	Fiyat	Ref.
12 disk paketi	2.009 €	1942
CL 50 Restoranlar	Fiyat	Ref.
7 disk paketi	1.210 €	1943
CL 50 - disksiz	Fiyat	Ref.
CL 50 230V/50/1	2.339 €	24440

CL 50 Ultra - 1V 2.491 €

Asenkron motor	✓
Güç	550 W
Voltaj	Tek fazlı 230 V
Hız	375 dev/dak.
Oluklar	2,2 L yarımay oluk Ø 58 mm ve Ø 39 mm silindirik oluk, Exactitube itici aparatı - Dahil
Kapak ve hazne	Metal
Motor bloku	Paslanmaz çelik
Diskler	Dahil değil

CL 50 Ultra Restoranlar	Fiyat	Ref.
8 disk paketi	1.215 €	1927
CL 50 Ultra Kurumlar	Fiyat	Ref.
12 disk paketi	2.009 €	1942
CL 50 Ultra Restoranlar	Fiyat	Ref.
7 disk paketi	1.210 €	1943
CL 50 Ultra - disksiz	Fiyat	Ref.
CL 50 Ultra 230V/50/1	2.491 €	24465

Tam disk koleksiyonu, sayfa 36



İsteğe bağlı parçaları seçin:

İsteğe bağlı parça	Ref.
Exactitube ek itme kolu	49212
3 mm püre aksesuarı	28207
6 mm püre aksesuarı	28209

CL 50 / CL 50 Ultra



CL 50 Ultra Pizza

Pizzalarınızı yapmak için kişiye özel teklif!

1 adet 4 mm dilimleme disk
domates, patlıcan...

1 adet 2 mm dilimleme diski
kabak, mantar, biber,
soğan...



1 adet 7 mm
rendeleme diski
Mozzarella veya özel
pizza peyniri.



Surface 139 cm²



CL 50 Ultra Pizza

2.931 €

Asenkron motor ✓

Güç 550 W

Voltaj Tek fazlı 230 V

Hız 375 dev/dak.

Oluklar 2,2 L yarımay oluk
Ø 58 mm ve Ø 39 mm silindirik oluk,
Exactitube itici aparatı - **Dahil**

Kapak ve hazne Metal

Motor bloku Paslanmaz çelik

Diskler 2 mm dilimleyici, 4 mm dilimleyici + 7 mm
rendeleyici - **Dahil**

Modelinizi seçin:

CL 50 Ultra Pizza	Fiyat	Ref.
CL 50 Ultra Pizza 230 V/50/1 - 3 disk	2.931 €	2027

Tam disk koleksiyonu, sayfa 36



CL 50 Ultra Pizza

İsteğe bağlı
parçaları seçin:

İsteğe bağlı parça	Ref.
Exactitube ek itme kolu	49212
3 mm püre aksesuarı	28207
6 mm püre aksesuarı	28209

CL 50 GOURMET

Mükemmellik tercihi

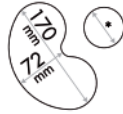

*Ara parçayla 58 mm
*Ara parçayla 68 mm

"Tüm disk paketlerini sayfa 45'da keşfedin!"

CL 50 Gourmet

3.720 €

Asenkron motor	✓
Güç	550 W
Voltaj	Tek fazlı 230 V
Hız	375 dev/dak.
Oluklar	2,1 L yarımay oluk Ø 58 mm ve Ø 68 mm silindirik oluk
Kapak ve hazne	Metal
Motor bloku	Paslanmaz çelik
Diskler	Dahil değil

Modelinizi seçin:

CL 50 Gourmet	Fiyat	Ref.
CL 50 Gourmet 220-240V/50/1	3.720 €	24453

Tam disk koleksiyonu, sayfa 36



3 Burnuaz

2 mm - 3 mm - 4 mm



Burnuaz

İsteğe bağlı parçalar	Ref.
2 x 2 x 2 mm burnuaz	28174
3 x 3 x 3 mm burnuaz	28175
4 x 4 x 4 mm burnuaz	28176

4 Waffle kesim

2 mm - 3 mm - 4 mm - 6 mm



waffle kesim

İsteğe bağlı parçalar	Ref.
2 mm waffle kesim	28198
3 mm waffle kesim	28199
4 mm waffle kesim	28177
6 mm waffle kesim	28178

Maydanoz ve aromatik bitki kiti

2 ara parça



1 mm'lik maydanoz ve ot kiti aşağıdakileri içerir:

1 mm'lik 1 dilimleyici ve kesme sırasında bitkileri korumak için 2 ara parça.

	Ref.
1 mm maydanoz kiti	28194

Tabule kiti aşağıdakileri içerir: 1 adet 1 mm dilimleyici, 10x10 mm küp kesim ekipmanı, 1 adet 4x4 mm burnuaz diski ve 3 ara parça.

	Ref.
Tabule kiti	28192

CL 52

Büyük hacimli sebzeleri hızla kesmek için tasarlanmıştır.



- Çalışma konforu
- MSD'lerin önlenmesi
- Zorluğun azaltılması



EKSTRA HASSAS

Silindirik oluk

- Uzun ürünlerin $\varnothing 58$ mm düzgün kesimi.
- Exactitube itme kolu sayesinde acı biber, salatalık turşusu, kuru sosis, kuşkonmaz, taze soğan, muz, çilek, üzüm gibi küçük meyve ve sebzelerin $\varnothing 39$ mm kesimi.

İNOVASYON



DİKKAT ÇEKİCİ ERGONOMİ

Kullanıcının daha az çabayla daha fazla üretmesini sağlayan takviyeli hareketli kol

EKSTRA BÜYÜK

Oluğun XL hacmi, bir defada 15 domatese kadar işlenmesine olanak tanır.



EKSTRA GÜÇLÜ

Motor bloku kolay bakım için paslanmaz çelikten imal edilmiştir. 750W ultra güçlü ve sessiz endüstriyel motor.

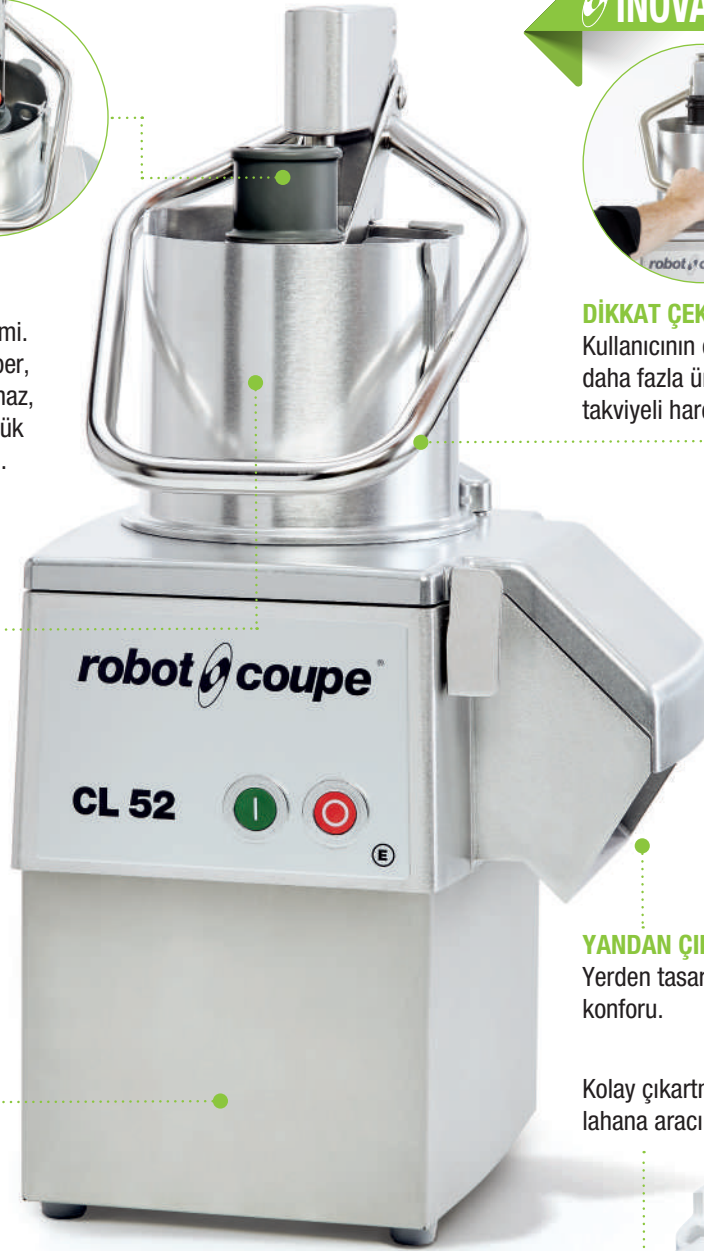

YANDAN ÇIKARMA

Yerden tasarruf ve çalışma konforu.

Kolay çıkartma için özel lahana aracı.





227 cm² yüzey

“Tüm disk paketlerini sayfa 45’da keşfedin!”

CL 52 - 1V

3.970 €

Asenkron motor



Güç 750 W

Voltaj Tek fazlı 230 V

Hız 375 dev/dak.

Oluklar 4,4 L tam daire oluk
Ø 58 mm ve Ø 39 mm silindirik oluk,
Exactitube itici aparatı - **Dahil**

Kapak ve hazne Metal

Motor bloku Paslanmaz çelik

Diskler Dahil değil

Modelinizi seçin:



Sebze doğrayıcıyı çalışırken görmek için bu QR-Kodunu tarayın.

CL 52 Restoranlar	Fiyat	Ref.
8 disk paketi	1.215 €	1927
CL 52 Kurumlar	Fiyat	Ref.
12 disk paketi	2.009 €	1942
CL 52 Restoranlar	Fiyat	Ref.
7 disk paketi	1.210 €	1943
CL 52 - disksiz	Fiyat	Ref.
CL 52 230V/50/1	3.970 €	24490

Tam disk koleksiyonu, sayfa 36



İsteğe bağlı parçaları seçin:

	CL 52
İsteğe bağlı parça	Ref.
Exactitube ek itme kolu	49221
3 mm püre ekipmanı	28208
6 mm püre ekipmanı	28210



AYAKLI SEBZE DOĞRAMA



CL 55 İtme Kafalı

7.041 €

CL 55 2 Kafalı

8.988 €

Asenkron motor



Güç

750 W

1100 W

Voltaj

Tek fazlı 230 V

Üç fazlı 400 V

Hız

375 dev/dak.

375 dev/dak. - 750 dev/dak.

Oluklar

4,4 L tam daire itmeli kafa
Ø 58 mm ve Ø 39 mm silindirik oluk,
Exactitube itme kolu - **Dahil**

Kapak ve hazne

Metal

Motor bloku

Paslanmaz çelik

Hareketli taban

Paslanmaz çelik - frenli 2 tekerlekle donatılmıştır

Diskler

Dahil değil

Modelinizi seçin:

CL 55 İtme Kafalı Restoranlar	Fiyat	Ref.
8 disk paketi	1.215 €	1927
CL 55 İtme Kafalı Kurumlar	Fiyat	Ref.
12 disk paketi	2.009 €	1942
CL 55 İtme Kafalı Restoranlar	Fiyat	Ref.
7 disk paketi	1.210 €	1943
CL 55 İtme Kafalı - disksiz	Fiyat	Ref.
CL 55 İtme Kafalı 230V/50/1	7.041 €	2245
CL 55 İtme Kafalı 400V/50/3	7.041 €	2214



750 W

1100 W

Tek fazlı 230 V

Üç fazlı 400 V

375 dev/dak.

375 dev/dak. - 750 dev/dak.

Paslanmaz çelik otomatik kafa
4,4 L tam daire itmeli kafa
Ø 58 mm ve Ø 39 mm silindirik oluk,
Exactitube itici aparatı - **Dahil**

Metal

Paslanmaz çelik

Paslanmaz çelik - frenli 2 tekerlekle donatılmıştır

Dahil değil

CL 55 2 Kafalı Restoranlar	Fiyat	Ref.
8 disk paketi	1.215 €	1927
CL 55 2 Kafalı Kurumlar	Fiyat	Ref.
12 disk paketi	2.009 €	1942
CL 55 2 Kafalı Restoranlar	Fiyat	Ref.
7 disk paketi	1.210 €	1943
CL 55 2 Kafalı - disksiz	Fiyat	Ref.
CL 55 2 Kafalı 230V/50/1	8.988 €	2244
CL 55 2 Kafalı 400V/50/3	8.988 €	2211

Tam disk koleksiyonu, sayfa 36



CL 55 AKSESUARLAR



Otomatik kafa
Ref. 28170



İtmeli kafa
entegre borulu (227 cm² yüzey)
Ref. 39673



4 tüplü kafa
2 adet Ø 50 mm boru
2 adet Ø 70 mm boru
Ref. 28161



Düz ve eğimli tüplü kafa
Ref. 28155



Püre ekipmanı
Ref. 28208 Ø 3 mm
Ref. 28210 Ø 6 mm



Exactitube itme kolu
Ref. 49221



3 farklı yüksekliğe ayarlanabilir GN 1/1 araba
Tepsisiz teslim edilir
Ref. 49128



16 disk, 8 ekipman ve 3 kafa için aksesuar saklama merdiveni, bir GN 1/1 tepsiyle teslim edilir (aksesuarlar dahil değildir)
Ref. 49132

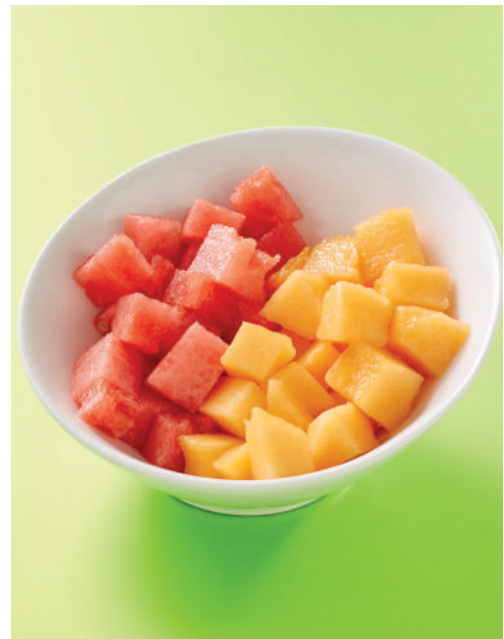

CL 55 Çalışma İstasyonu

Eksiksiz çözüm

Saatte
1200 kg
sebzeye
kadar

175 mm

59 mm

227 cm² yüzey

AYARLANABİLİR ARABA

3 farklı yükseklik

Sebze ve meyveleri kolayca taşıyıp yüklemek ve aksesuarları saklamak için.



CL 55 Çalışma İstasyonu

12.924 €

Asenkron motor	✓	
Güç	750 W	1100 W
Voltaj	Tek fazlı 230 V	Üç fazlı 400 V
Hız	375 dev/dak.	375 dev/dak. - 750 dev/dak.
Oluklar	Paslanmaz çelik otomatik kafa 4,4 L tam daire itmeli kafa Ø 58 mm ve Ø 39 mm silindirik oluk, Exactitube itme kolu - Dahil	
Kapak ve hazne	Metal	
Motor bloku	Paslanmaz çelik	
Aksesuarlar	Paslanmaz çelik hareketli taban - Frenli 2 tekerlekle donatılmıştır - Dahil 3 yüksekliğe ayarlanabilir GN 1/1 araba, + 3 adet GN 1/1 tepsi - Dahil 3 mm püre ekipmanı - Dahil	
Diskler	16 diskli MultiCut paketi - Dahil	

CL 55 Çalışma İstasyonu	Fiyat	Ref.
CL 55 Çalışma İstasyonu 230V/50/1	12.924 €	2290
CL 55 Çalışma İstasyonu 400V/50/3	12.924 €	2287

AKSESUARLAR DAHİL EKSIKSİZ BİR KOLEKSİYON!

Otomatik kafa

Yığın halindeki bütün sebzeler için (domates, soğan, patates...).



İtmeli kafa

Lahana veya kereviz gibi hacimli sebzeler için özel.



16 diskli MultiCut paketi

16 disk dahil.

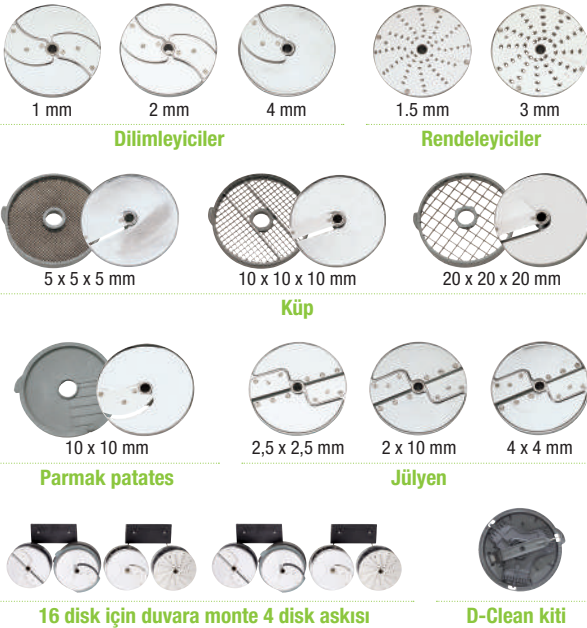

Exactitube itici aparatı

Küçük boy meyve ve sebze, acı biber, salatalık turşusu, kuru sosis, kuşkonmaz, taze soğan, muz, çilek, üzüm doğramak için...



3 mm püre ekipmanı

Büyük miktarlarda, kaliteli ve lezzetli taze püre yapmak için.



GN 1/1 ayarlanabilir araba

Ürünlerin taşınması, yüklenmesi ve aksesuarların saklanması için.

2 adet GN 1/1 tepsi temin edilir.



Üretim modu

Depolama modu

AYAKLI SEBZE DOĞRAMA



CL 60 1tme Kafalı 10.328 €

CL 60 2 Kafalı 13.367 €

Asenkron motor	✓
Güç	1500 W
Voltaj	Üç fazlı 400V
Hız	375 dev/dak. - 750 dev/dak.
Oluklar	4,9 L tam daire itmeli kafa Ø 58 mm ve Ø 39 mm silindirik oluk, Exactitube itici aparatı - Dahil
Hazne	Paslanmaz çelik
Motor bloku	Paslanmaz çelik
Ekipman	Tüm ayaklı modeller için 1 ayarlanabilir ayak 2 tekerlek Doğrama aletleri için 1 paslanmaz çelik tepsi
Diskler	Dahil değil

Asenkron motor	✓
Güç	1500 W
Voltaj	Üç fazlı 400V
Hız	375 dev/dak. - 750 dev/dak.
Oluklar	Paslanmaz çelik otomatik kafa 4,4 L tam daire itmeli kafa Ø 58 mm ve Ø 39 mm silindirik oluk, Exactitube itici aparatı - Dahil
Hazne	Paslanmaz çelik
Motor bloku	Paslanmaz çelik
Ekipman	Tüm ayaklı modeller için 1 ayarlanabilir ayak 2 tekerlek Doğrama aletleri için 1 paslanmaz çelik tepsi
Diskler	Dahil değil

Modelinizi seçin:



Sebze doğrayıcıyı çalışırken görmek için bu QR-Kodunu tarayın.

CL 60 1tme Kafalı Restoranlar	Fiyat	Ref.
8 disk paketi	1.215 €	1927
CL 60 1tme Kafalı Kurumlar	Fiyat	Ref.
12 disk paketi	2.009 €	1942
CL 60 1tme Kafalı Restoranlar	Fiyat	Ref.
7 disk paketi	1.210 €	1943
CL 60 1tme Kafalı - disksiz	Fiyat	Ref.
CL 60 1tme Kafalı 400V/50/3	10.328 €	2319

CL 60 2 Kafalı Restoranlar	Fiyat	Ref.
8 disk paketi	1.215 €	1927
CL 60 2 Kafalı Kurumlar	Fiyat	Ref.
12 disk paketi	2.009 €	1942
CL 60 2 Kafalı Restoranlar	Fiyat	Ref.
7 disk paketi	1.210 €	1943
CL 60 2 Kafalı - disksiz	Fiyat	Ref.
CL 60 2 Kafalı 400V/50/3	13.367 €	2325

Tam disk koleksiyonu, sayfa 36



CL 60 AKSESUARLARI



Otomatik kafa
Besleme plakalı
Ref. 39681



İtmeli kafa
Ref. 39680



4 tüplü kafa
2 adet Ø 50 mm boru
2 adet Ø 70 mm boru
Ref. 28162



Düz ve eğimli tüplü kafa
Ref. 28157



Püre ekipmanı
Ref. 28208 Ø 3 mm
Ref. 28210 Ø 6 mm



YENİ

Exactitube itme kolu
Ref. 49221



Ergomobile araba
Tepsisiz teslim edilir.
3 adet GN 1/1 tepsi alacak
şekilde tasarlanmıştır.
Ref. 49066



16 disk, 8 ekipman ve 3 kafa için
aksesuar saklama merdiveni, bir
GN1/1 kapla birlikte teslim edilir
(aksesuarlar dahil değildir)
Ref. 49132



CL 60 Çalışma İstasyonu

Eksiksiz çözüm

Saatte
1200 kg
sebzeye
kadar

AKSESUAR SAKLAMA ARABASI



Farklı zemin seviyelerine
uyum sağlamak için
ayarlanabilir ayak.



CL 60 Çalışma İstasyonu

21.444 €

Asenkron motor	✓
Güç	1500 W
Voltaj	Üç fazlı 400 V
Hız	375 dev/dak. - 750 dev/dak.
Oluklar	Paslanmaz çelik otomatik kafa 4,9 L tam daire itmeli kafa Ø 58 mm ve Ø 39 mm silindirik oluk, Exactitube itici aparatı - Dahil 4 boru: 2 adet Ø 50 mm boru ve 2 adet Ø 70 mm boru
Kapak ve hazne	Metal
Motor bloku	Paslanmaz çelik
Ekipman	Tüm ayaklı modeller için 1 ayarlanabilir ayak, 2 tekerlek, doğrama aletleri için 1 paslanmaz çelik tepsi
Aksesuarlar	3 adet GN 1/1 tepsili Ergomobil boşaltım arabası - Dahil 1 adet GN 1/1 tepsili aksesuar saklama arabası - Dahil 3 mm püre ekipmanı - Dahil
Diskler	16 diskli MultiCut paketi - Dahil

CL 60 Çalışma İstasyonu	Fiyat	Ref.
CL 60 Çalışma İstasyonu 400V/50/3	21.444 €	2300



Sebze doğrayıcıyı
çalışırken görmek için
bu QR-Kodunu tarayın.

AKSESUARLAR DAHİL EKSIKSİZ BİR KOLEKSİYON!

Otomatik kafa

Yığın halindeki bütün sebzeler için (domates, soğan, patates...).



İtmeli kafa

Lahana veya kereviz gibi hacimli sebzeler için özel.



4 tüplü kafa

Salatalık ve kabak gibi uzun sebzeler için özel.



Exactitube itici aparatı

Küçük boy meyve ve sebze, acı biber, salatalık turşusu, kuru sosis, kuşkonmaz, taze soğan, muz, çilek, üzüm doğramak için...



3 mm püre ekipmanı

Büyük miktarlarda, kaliteli ve lezzetli taze püre yapmak için.



Aksesuar saklama arabası

Tüm Taze Beslenme aksesuarlarını saklamak ve taşımak için! 16 disk ve 8 ekipman için tepsi. Mutfak eşyaları için GN1X1 tepsi.



16 diskli MultiCut paketi

16 disk dahil.

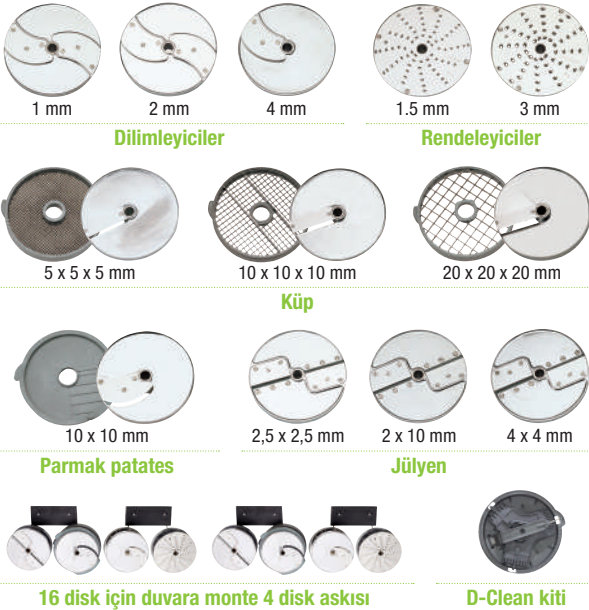

Ergomobile araba

Ürünlerin taşınması, yüklenmesi ve aksesuarların saklanması için. 3 adet GN 1/1 tepsi temin edilir.



PARÇALAYICI MİKSERLER



SET ÜSTÜ PARÇALAYICI MİKSERLER



R 2 1.511 €

Asenkron motor	✓
Güç	550 W
Voltaj	Tek fazlı 230 V
Hız	1500 dev/dak.
Darbe	✓
Hazne	2,9 L paslanmaz çelik
Bıçak	Paslanmaz çelik düz bıçak kanatları - Dahil



R 3 1.985 €

Asenkron motor	✓
Güç	650 W
Voltaj	Tek fazlı 230 V
Hız	1500 dev/dak.
Darbe	✓
Hazne	3,7 L paslanmaz çelik
Bıçak	Paslanmaz çelik düz bıçak kanatları - Dahil

Modelinizi seçin:

R 2	Fiyat	Ref.
R 2 230V/50/1	1.511 €	22100

R 3	Fiyat	Ref.
R 3 230V/50/1	1.985 €	22382

İsteğe bağlı parçaları seçin:



İsteğe bağlı parçalar	R 2	R 3
	Ref.	Ref.
Kalın dişli bıçak Pastacılık öğütme işlemleri için özel	27138	27288
İnce dişli bıçak Otlar ve Baharatlar için özel	27061	27287
Ek düz bıçak	27055	27286
Duvara monte bıçak askısı	107810	107810



R 4 - 2V

2.483 €

Asenkron motor	✓
Güç	900 W
Voltaj	Üç fazlı 400 V
Hız	1500 - 3000 dev/dak.
Darbe	✓
Motor desteği	Metal
Hazne	4,5 L paslanmaz çelik
Bıçak	Paslanmaz çelik düz bıçak kanatları - Dahil



R 4 - 1V

2.301 €

Asenkron motor	✓
Güç	700 W
Voltaj	Tek fazlı 230 V
Hız	1500 dev/dak.
Darbe	✓
Motor desteği	Metal
Hazne	4,5 L paslanmaz çelik
Bıçak	Paslanmaz çelik düz bıçak kanatları - Dahil

Modelinizi seçin:

R 4 - 2V	Fiyat	Ref.
R 4 - 2V 400/50/3	2.483 €	22437

R 4 - 1V	Fiyat	Ref.
R 4 - 1V 230/50/1	2.301 €	22430

İsteğe bağlı parçaları seçin:



İsteğe bağlı parçalar	Ref.
Kalın dişli bıçak Pastacılık öğütme işlemleri için özel	27346
İnce dişli bıçak Otlar ve Baharatlar için özel	27345
Ek düz bıçak	27344
Duvara monte bıçak askısı	107810

R 4 tüm modeller



SET ÜSTÜ PARÇALAYICI MİKSERLER



R 5 - 1V 3.022 €

Asenkron motor	✓
Güç	1100 W
Voltaj	Tek fazlı 230 V
Hız	1500 dev/dak.
Darbe	✓
Motor desteği	Metal
Hazne	5,5 L paslanmaz çelik
Bıçak	Paslanmaz çelik düz bıçak kanatları - Dahil
R-Mix®	-



R 5 - 2V 3.090 €

Asenkron motor	✓
Güç	1200 W
Voltaj	Üç fazlı 400 V
Hız	1500 - 3000 dev/dak.
Darbe	✓
Motor desteği	Metal
Hazne	5,5 L paslanmaz çelik
Bıçak	Paslanmaz çelik düz bıçak kanatları - Dahil
R-Mix®	-

Modelinizi seçin:

R 5 - 1V	Fiyat	Ref.
R 5 - 1V 230V/50/1	3.022 €	24608

R 5 - 2V	Fiyat	Ref.
R 5 - 2V 400V/50/3	3.090 €	24614

İsteğe bağlı parçaları seçin:



R 5 tüm modeller		Ref.
İsteğe bağlı parçalar		
Kalın dişli bıçak	Pastacılık öğütme işlemleri için özel	27121
İnce dişli bıçak	Otlar ve Baharatlar için özel	27351
Ek düz bıçak		27120



R 7 V.V. 4.531 €

Asenkron motor	✓
Güç	1500 W
Voltaj	Tek fazlı 230 V
Hız	300 ila 3500 dev/dak.
Darbe	✓
Motor desteği	Metal
Hazne	7,5 L paslanmaz çelik
Bıçak	Tamamen paslanmaz çelik, çıkarılabilir ve ayarlanabilir düz bıçak kanatları - Dahil
R-Mix®	✓

R 8 5.311 €

Asenkron motor	✓
Güç	2200 W
Voltaj	Üç fazlı 400 V
Hız	1500 - 3000 dev/dak.
Darbe	✓
Motor desteği	-
Hazne	8 L paslanmaz çelik
Bıçak	Tamamen paslanmaz çelik, 2 adet çıkarılabilir ve ayarlanabilir düz bıçak kanadı - Dahil
R-Mix®	-

Modelinizi seçin:

R 7 V.V.	Fiyat	Ref.
R 7 V.V. 230V/50-60/1	4.531 €	24709

R 8	Fiyat	Ref.
R 8 400V/50/3	5.311 €	21291

İsteğe bağlı parçaları seçin:



İsteğe bağlı parçalar	R 7 V.V.	R 8
	Ref.	Fiyat Ref.
Paslanmaz çelik kalın dişli bıçak Pastacılık öğütme işlemleri için özel	27125	-
Paslanmaz çelik ince dişli bıçak Otlar ve Baharatlar için özel	27352	-
Ek düz paslanmaz çelik bıçak	27124	-
Alt kalın dişli bıçak kanadı	49162	-
Üst kalın dişli bıçak kanadı	49163	-
Alt düz bıçak kanadı	49160	-
Üst düz bıçak kanadı	49161	-
Alt ince dişli bıçak kanadı	49164	-
Üst ince dişli bıçak kanadı	49165	-
2 kanatlı, kalın dişli paslanmaz çelik bıçak Pastacılık öğütme işlemleri için özel	-	27383
2 kanatlı, ince dişli paslanmaz çelik bıçak Otlar ve Baharatlar için özel	-	27385
2 ek kanatlı, düz paslanmaz çelik bıçak	-	27381
Kalın dişli bıçak kanadı	-	59281
İnce dişli bıçak kanadı	-	59282
Düz bıçak kanadı	-	59280
R-VAC® vakum cihazı	-	29996
Vakum pompası 550 W - 16m3/s	-	69012

DİK TİP PARÇALAYICILAR

AYAKLI

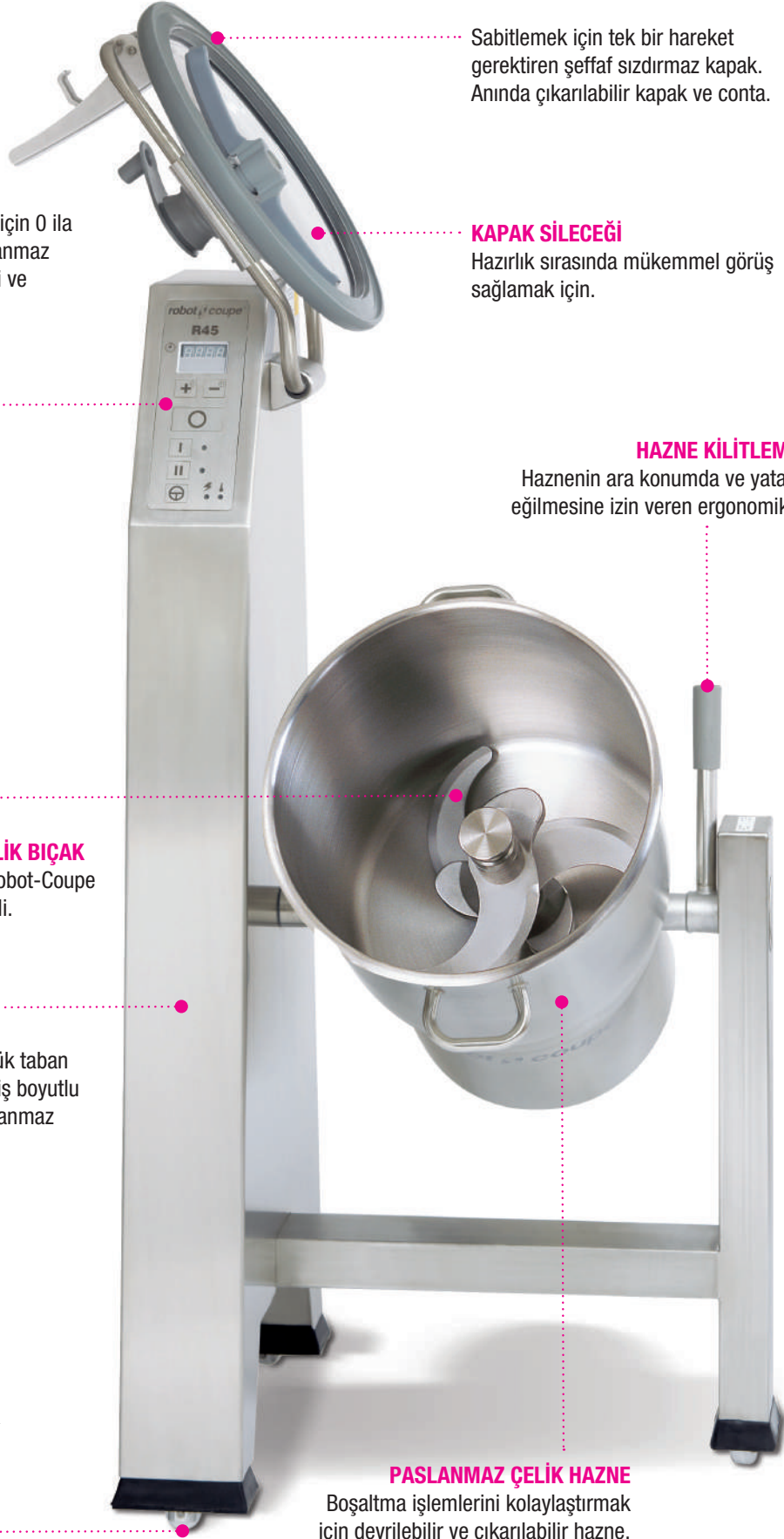

KONTROL PANELİ

Mükemmel kesme hassasiyeti için 0 ila 15 dakikalık zamanlayıcı, paslanmaz çelik gömme kontrol düğmeleri ve kesintili kumanda.

Sabitlemek için tek bir hareket gerektiren şeffaf sızdırmaz kapak. Anında çıkarılabilir kapak ve conta.

KAPAK SİLECEĞİ

Hazırlık sırasında mükemmel görüş sağlamak için.

HAZNE KİLİTLEME KOLU

Haznenin ara konumda ve yatay olarak eğilmesine izin veren ergonomik özellik.

İNOVASYON

HAZNE ALTI PASLANMAZ ÇELİK BİÇAK

Optimum kesme kalitesi için Robot-Coupe patentli yeni bıçak kanadı profili.

PASLANMAZ ÇELİK ŞASI

Mükemmel stabilite, daha küçük taban alanı ve kolay temizlik için geniş boyutlu 3 ayak sistemli, tamamen paslanmaz çelik konstrüksiyon.

TEKERLEKLER DAHİL

Kolay hareket ve kolay temizlik için 3 gizlenebilir tekerlek.

PASLANMAZ ÇELİK HAZNE

Boşaltma işlemlerini kolaylaştırmak için devrilebilir ve çıkarılabilir hazne.

OPTİMUM SONUÇ İÇİN 3 BİÇAK



Düz bıçak standart

İri KIYMA

İNCE KIYMA

SOSLAR, EMÜLSİYONLAR

Kalın dişli bıçak

ÖZEL Pastacılıkta Öğütme İşlemleri

YOĞURMA

ÖĞÜTME

İnce dişli bıçak

ÖZEL Otlar Baharatlar

OT KIYMA

BAHARAT KIYMA

VAKUM FONKSİYONU R-Vac®

R-Vac® cihazı, balık musları, sarmalar, sebze yahnileri, kaz ciğeri blokları, ganaş gibi her türlü preparat için eşsiz kalitede sonuçlar elde edebilecek şekilde hava vakumlu çalışmaya olanak tanır.

Vakumlu çalışmanın avantajları:

- Mükemmel koruma
- Mükemmel sunum
- Mükemmel aroma ve tat geliştirme
- Mükemmel pişirme



DİK TİP PARÇALAYICILAR



Miktarlar*



4 ila 17



6 ila 27



6 ila 36

2 HIZ AYARI 1500 ve 3000 dev/dak.

R 30



3
İSTEGE BAĞLI
BİÇAKLAR
28 L

• Üç fazlı

R 45



3
İSTEGE BAĞLI
BİÇAKLAR
45 L

• Üç fazlı

R 60



3
İSTEGE BAĞLI
BİÇAKLAR
60 L

• Üç fazlı



Miktarlar*



3 ila 9



3 ila 12



4 ila 14

2 HIZ AYARI 1500 ve 3000 dev/dak.

R 15



3
İSTEGE BAĞLI
BİÇAKLAR
15 L

• Üç fazlı

R 20



3
İSTEGE BAĞLI
BİÇAKLAR
20 L

• Üç fazlı

R 23



3
İSTEGE BAĞLI
BİÇAKLAR
23 L

• Üç fazlı

* İşlem başına çalışma miktarları

ÇALIŞMA KAPASİTELERİ

Modeller	Maksimum yük kapasitesi				Kuver sayısı	Çalışma süresi
	Kıyma (en fazla)	Emülsiyonlar (en fazla)	Hamur* (en fazla)	Broyages (en fazla)		
R 15	6 kg	9 kg	7,0 kg	7,0 kg	50 ile 250 arası	1 ila 4 dakika
R 20	8 kg	12 kg	10,0 kg	10,0 kg	50 ile 300 arası	
R 23	10 kg	14 kg	11,5 kg	11,5 kg	100 ile 400 arası	
R 30	12 kg	17 kg	14,0 kg	14,0 kg	100 ile 500 arası	
R 45	18 kg	27 kg	22,5 kg	22,5 kg	200 ile 1000 arası	
R 60	25 kg	36 kg	30,0 kg	30,0 kg	300 ile 3000 arası	

* %60 oranında nemlendirilmiş mayalı hamur miktarı

Tüm set üstü modelleri sayfa 78'te bulabilirsiniz



R 10 8.356 €

Asenkron motor

✓

Güç

2600 W

Voltaj

Üç fazlı 400 V

Hız

1500 - 3000 dev/dak.

Darbe

✓

Hazne

11,5 L paslanmaz çelik

Bıçak

Tamamen paslanmaz çelik, 3 adet çıkarılabilir ve ayarlanabilir düz bıçak kanadı - **Dahil**

R 15 9.151 €

✓

3000 W

Üç fazlı 400 V

1500 - 3000 dev/dak.

✓

15 L paslanmaz çelik

Tamamen paslanmaz çelik, 3 adet çıkarılabilir ve ayarlanabilir düz bıçak kanadı - **Dahil**

R 20 9.954 €

✓

4400 W

Üç fazlı 400 V

1500 - 3000 dev/dak.

✓

20 L paslanmaz çelik

Tamamen paslanmaz çelik, 3 adet çıkarılabilir ve ayarlanabilir düz bıçak kanadı - **Dahil**

R 10	Fiyat	Ref.
R 10 400V/50/3	8.356 €	21391

R 15	Fiyat	Ref.
R 15 400V/50/3	9.151 €	51491

R 20	Fiyat	Ref.
R 20 400V/50/3	9.954 €	51591

İsteğe bağlı parçaları seçin:

İsteğe bağlı parçalar	R 10	R15 / R 20
3 kanatlı, kalın dişli paslanmaz çelik bıçak Pastacılık öğütme işlemleri için özel	Ref. 27384	Ref. 57098
3 kanatlı, ince dişli paslanmaz çelik bıçak Otlar ve Baharatlar için özel	Ref. 27386	Ref. 57099
3 ek kanatlı paslanmaz çelik düz bıçak	Ref. 27382	Ref. 57097
Kalın dişli bıçak kanadı	Ref. 59281	Ref. 59393
İnce dişli bıçak kanadı	Ref. 59282	Ref. 59359
Düz bıçak kanadı	Ref. 59280	Ref. 59392
R-VAC® vakum cihazı	Ref. 29996	Ref. 29996
Vakum pompası 550 W - 16m ³ /s	Ref. 69012	Ref. 69012



İsteğe bağlı ek mini hazneler	R 15	Ref.
4,5 litre paslanmaz çelik hazne R 15 Paslanmaz çelik düz bıçak dahil	Ref. 27375	Ref. 27375
Paslanmaz çelik kalın dişli bıçak	Ref. 27107	Ref. 27107
Ek düz paslanmaz çelik bıçak	Ref. 27106	Ref. 27106
Kalın dişli bıçak kanadı	Ref. 101801S	Ref. 101801S
Düz bıçak kanadı	Ref. 101800S	Ref. 101800S

Modelinizi seçin:

DİK TİP PARÇALAYICILAR



R 23 14.637 €

Asenkron motor	✓
Güç	4500 W
Voltaj	Üç fazlı 400 V
Hız	1500 - 3000 dev/dak.
Darbe	✓
Dijital zamanlayıcı IP65 kontrol paneli	✓
Hazne	23 L paslanmaz çelik
Kapak sileceği	✓
Bıçak	Tamamen paslanmaz çelik, 3 adet çıkarılabilir ve ayarlanabilir düz bıçak kanadı - Dahil
3 katlanır tekerlek	✓

R 30 17.690 €

Asenkron motor	✓
Güç	5400 W
Voltaj	Üç fazlı 400 V
Hız	1500 - 3000 dev/dak.
Darbe	✓
Dijital zamanlayıcı IP65 kontrol paneli	✓
Hazne	28 L paslanmaz çelik
Kapak sileceği	✓
Bıçak	Tamamen paslanmaz çelik, 3 adet çıkarılabilir ve ayarlanabilir düz bıçak kanadı - Dahil
3 katlanır tekerlek	✓

Modelinizi seçin:

R 23	Fiyat	Ref.
R 23 400V/50/3	14.637 €	51331C

R 30	Fiyat	Ref.
R 30 400V/50/3	17.690 €	52331C



Scannez ce QR-Code
pour voir le cutter vertical
en action.

İsteğe bağlı
parçaları seçin:

	R 23	R 30
İsteğe bağlı parçalar	Ref.	Ref.
3 kanatlı, kalın dişli paslanmaz çelik bıçak Pastacılık öğütme işlemleri için özel	57070	57075
3 kanatlı, ince dişli paslanmaz çelik bıçak Otlar ve Baharatlar için özel	57072	57077
3 ek kanatlı paslanmaz çelik düz bıçak	57069	57074
Kalın dişli bıçak kanadı	118294S	118286S
İnce dişli bıçak kanadı	118292S	118241S
Düz bıçak kanadı	118217S	117950S
3 farklı yüksekliğe ayarlanabilir GN1x1 araba	49128	49128
Vakum pompası 550 W - 16m³/s	69012	69012



R 45 23.783 €

Asenkron motor	✓
Güç	10000 W
Voltaj	Üç fazlı 400 V
Hız	1500 - 3000 dev/dak.
Darbe	✓
Dijital zamanlayıcı IP65 kontrol paneli	✓
Hazne	45 L paslanmaz çelik
Kapak sileceği	✓
Bıçak	Tamamen paslanmaz çelik, 3 adet çıkarılabilir ve ayarlanabilir düz bıçak kanadı - Dahil
3 katlanır tekerlek	✓

R 60 32.979 €

Asenkron motor	✓
Güç	11000 W
Voltaj	Üç fazlı 400 V
Hız	1500 - 3000 dev/dak.
Darbe	✓
Dijital zamanlayıcı IP65 kontrol paneli	✓
Hazne	60 L paslanmaz çelik
Kapak sileceği	✓
Bıçak	Tamamen paslanmaz çelik, 3 adet çıkarılabilir ve ayarlanabilir düz bıçak kanadı - Dahil
3 katlanır tekerlek	✓

Modelinizi seçin:

R 45	Fiyat	Ref.
R 45 400V/50/3	23.783 €	53331C

R 60	Fiyat	Ref.
R 60 400V/50/3	32.979 €	54331C

İsteğe bağlı parçaları seçin:

	R 45	R 60
İsteğe bağlı parçalar	Ref.	Ref.
3 kanatlı, kalın dişli paslanmaz çelik bıçak Pastacılık öğütme işlemleri için özel	57082	57092
3 kanatlı, ince dişli paslanmaz çelik bıçak Otlar ve Baharatlar için özel	57084	57095
3 ek kanatlı paslanmaz çelik düz bıçak	57081	57091
Kalın dişli bıçak kanadı	118287S	118290S
İnce dişli bıçak kanadı	118243S	118245S
Düz bıçak kanadı	117952S	117954S
3 farklı yüksekliğe ayarlanabilir GN1x1 araba	49128	49128
Vakum pompası 550 W - 16m³/s	69012	69012

ROBOT COOK®

COOKING CUTTER BLENDER



ROBOT COOK®

ŞEFLERİN MUTFAK ASİSTANI

Zekice: Sızdırmaz kapakta entegre güvenlik fonksiyonu bulunur. Buhar önleyici kapak sileceği hazırlanan karışımın kontrolüne olanak tanır.



Ustaca: Hazırlanan karışımı tam güvenlik içinde boşaltmak için benzersiz bıçak tutma sistemi.

Hijyen: Besinlere temas eden tüm parçalar kolayca çıkartılabilir ve makinede yıkanabilir.

Sessiz: Fırınların telaşının içinde, Şefler sessizliğini takdir eder.

Pratik: Cihazı durdurmadan, malzeme eklenmesine olanak tanıyan kapak üstü delik.

Etkili: Haznenin sıyrma spatulası sayesinde ultra ince ve homojen tarifler hazırlamak mümkün.

Fonksiyonel: 3,7 litrelik geniş kapasite sayesinde, profesyonel miktarlarda üretim yapabilirsiniz.

Güçlü: Robot Cook® gücünü son derece sağlam bir asenkron endüstriyel motora borçludur.

Ultra hassas: 140°C'ye kadar derece derece ayarlanabilir ısıtma gücü.



1 2 3
UYGULAMA ALANI

Döner düğme
(parametre ayarı)

AYAR BÖLGESİ

- 140°C'ye kadar küçük ve büyük ısıtma gücü fonksiyonu
- 500 ila 3500 dev/dak. arasında hız fonksiyonu
- Zamanlayıcı Fonksiyonu

PROGRAMLAMA BÖLGESİ

- P Program fonksiyonu
- Aşama düğmesi

UYGULAMA ALANI

- 1 Turbo/Darbe fonksiyonu: 4500 dev/dak.'ya kadar
- 2 Çalıştırma Düğmesi
- 3 Durdurma Düğmesi

ROBOT COOK® COOKING CUTTER BLENDER



ROBOT COOK®

3.856 €

Asenkron motor	✓
Güç	1800 W
Voltaj	Tek fazlı 230 V
Hız	<ul style="list-style-type: none"> • 100 ila 3500 dev/dak. arasında değişken hız • 4500 dev/dak. yüksek turbo hızı • -100 ila -500 dev/dak. arasında R-Mix karıştırma hızı • Düşük hızda 2 saniyede bir aralıklı bıçak dönüş hızı
Isıtma sıcaklığı	140°C'ye kadar
Darbe	✓
Hazne	3,7 L paslanmaz çelik
Sıyırıcı kol	✓
Bıçaklar	Blender fonksiyonlu, ince dişli kanatlı özel bıçak Dahil Kesici fonksiyonlu, düz kanatlı özel bıçak - Dahil

Modelinizi seçin:



Robot Cook®'u çalışırken görmek için bu QR-Kodunu tarayın.

ROBOT COOK®	Fiyat	Ref.
Robot Cook 230V/50-60/1	3.856 €	43000R
Robot Cook 230V/50-60/1 + ek hazne takımı		2074

İsteğe bağlı parçaları seçin:

İsteğe bağlı parçalar	Ref.
İnce dişli bıçakla birlikte ek hazne takımı	39854
Ek Kesici fonksiyonlu düz bıçak	49691
Ek Blender fonksiyonlu ince dişli bıçak	39691

EMÜLSİYONLAŞTIRMA



DOĞRAMA



KARIŞTIRMA



UFALAMA



KARIŞTIRMA



YOĞURMA



BLIXER®





Blixer® 3

2.274 €

Asenkron motor	✓
Güç	750 W
Voltaj	Tek fazlı 230 V
Hız	3000 dev/dak.
Darbe	✓
Motor desteği	Kompozit malzeme
Hazne	3,7 L paslanmaz çelik
Sızdırmaz kapak	✓
Blixer® kolu	✓
Bıçak	Çıkarılabilir kapaklı, paslanmaz çelik ince dişli bıçak kanatları - Dahil
200 g porsiyon sayısı	2-10



Modelinizi seçin:



Blixer'ı çalışırken görmek için bu QR-Kodunu tarayın.

Blixer® 3	Fiyat	Ref.
Blixer 3 230V/50/1	2.274 €	33197
Blixer 3 230V/50/1 + ek hazne grubu		2341

İsteğe bağlı parçaları seçin:

Blixer® 3	
İsteğe bağlı parçalar	Ref.
Ek hazne grubu: hazne, ince dişli bıçak, kapak ve Blixer® kolu	27337
Ek ince dişli bıçak	27347
Kalın dişli bıçak	27348

SET ÜSTÜ BLIXER®



Blixer® 4 - 1V

2.589 €

Asenkron motor	✓
Güç	900 W
Voltaj	Tek fazlı 230 V
Hız	3000 dev/dak.
Darbe	✓
Motor desteği	Metal
Hazne	4,5 L paslanmaz çelik
Sızdırmaz kapak	✓
Blixer® kolu	✓
Bıçak	Çıkarılabilir kapaklı, paslanmaz çelik ince dişli bıçak kanatları Dahil
200 g porsiyon sayısı	2-15

Blixer® 4 - 2V

2.768 €

Asenkron motor	✓
Güç	1000 W
Voltaj	Üç fazlı 400 V
Hız	1500 dev/dak. - 3000 dev/dak.
Darbe	✓
Motor desteği	Metal
Hazne	4,5 L paslanmaz çelik
Sızdırmaz kapak	✓
Blixer® kolu	✓
Bıçak	Çıkarılabilir kapaklı, paslanmaz çelik ince dişli bıçak kanatları Dahil
200 g porsiyon sayısı	2-15

Blixer® 4 V.V.

3.309 €

Asenkron motor	✓
Güç	1100 W
Voltaj	Tek fazlı 230 V
Hız	300 ila 3500 dev/dak.
Darbe	✓
Motor desteği	Metal
Hazne	4,5 L paslanmaz çelik
Sızdırmaz kapak	✓
Blixer® kolu	✓
Bıçak	Çıkarılabilir kapaklı, paslanmaz çelik ince dişli bıçak kanatları Dahil
200 g porsiyon sayısı	2-15

Modelinizi seçin:



Blixer'ı çalışırken görmek için bu QR-Kodunu tarayın.

Blixer® 4 - 1V	Fiyat	Ref.
Blixer 4-1V 230V/50/1	2.589 €	33208
Blixer 4-1V 230V/50/1 + ek hazne grubu		2343

Blixer® 4 - 2V	Fiyat	Ref.
Blixer 4-2V 400V/50/3	2.768 €	33215
Blixer 4-2V 400V/50/3 + ek hazne grubu		2342

Blixer® 4 V.V.	Fiyat	Ref.
Blixer 4 V.V. 230V/50-60/1	3.306 €	33220
Blixer 4 V.V. 230V/50-60/1 + ek hazne grubu		2344

İsteğe bağlı parçaları seçin:

İsteğe bağlı parçalar	Ref.
EK hazne grubu: hazne, ince dişli bıçak, kapak ve Blixer® kolu	27338
EK ince dişli bıçak	27349
Kalın dişli bıçak	27350

Blixer® 4 tüm modeller



Blixer® 5 - 2V 3.543 €

Asenkron motor	✓
Güç	1500 W
Voltaj	Üç fazlı 400 V
Hız	1500 dev/dak. - 3000 dev/dak.
Darbe	✓
Motor desteği	Metal
Hazne	5,9 L paslanmaz çelik
Sızdırmaz kapak	✓
Blixer® kolu	✓
Bıçak	Çıkarılabilir kapaklı, paslanmaz çelik ince dişli bıçak kanatları - Dahil
200 g porsiyon sayısı	3-20

Blixer® 5 V.V. 4.292 €

Asenkron motor	✓
Güç	1500 W
Voltaj	Tek fazlı 230 V
Hız	300 ila 3500 dev/dak.
Darbe	✓
Motor desteği	Metal
Hazne	5,9 L paslanmaz çelik
Sızdırmaz kapak	✓
Blixer® kolu	✓
Bıçak	Çıkarılabilir kapaklı, paslanmaz çelik ince dişli bıçak kanatları - Dahil
200 g porsiyon sayısı	3-20

Modelinizi seçin:

Blixer® 5 - 2V	Fiyat	Ref.
Blixer 5 - 2V 400V/50/3	3.543 €	33259
Blixer 5 - 2V 400V/50/3 + ek hazne grubu		2345

Blixer® 5 V.V.	Fiyat	Ref.
Blixer 5 V.V. 230V/50-60/1	4.292 €	33266
Blixer 5 V.V. 230V/50-60/1 + ek hazne grubu		2346

İsteğe bağlı parçaları seçin:

İsteğe bağlı parçalar	Ref.
Ek hazne grubu: hazne, ince dişli bıçak, kapak ve Blixer® kolu	27165
Ek ince dişli bıçak	27155
Kalın dişli bıçak	27180

Blixer® 5 tüm modeller

EL MİKSERLERİ



EL MİKSERLERİ

MİNİ

Mini MP



220 W MicroMix®
240 W Mini MP 160 V.V.
270 W Mini MP 190 V.V.
290 W Mini MP 240 V.V.

KOMPAKT

CMP



310 W CMP 250 V.V.
350 W CMP 300 V.V.
400 W CMP 350 V.V.

15 litre 30 litre 45 litre

BÜYÜK

MP



440 W MP 350 Ultra
500 W MP 450 Ultra
750 W MP 550 Ultra
850 W MP 600 Ultra
1000 W MP 800 Turbo

50 litre 100 litre 200 litre 300 litre 400 litre

Özel Emülsiyonlar

Özel Küçük Karışımlar





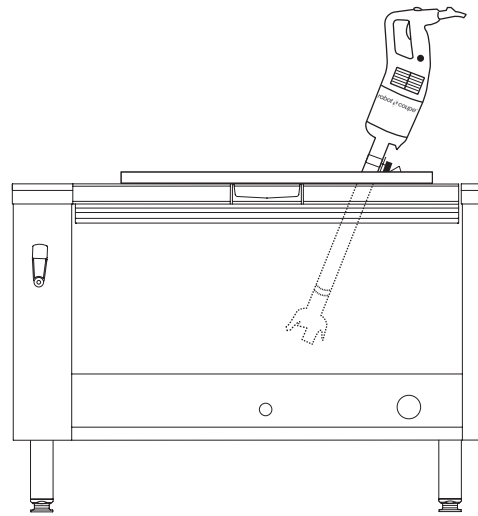
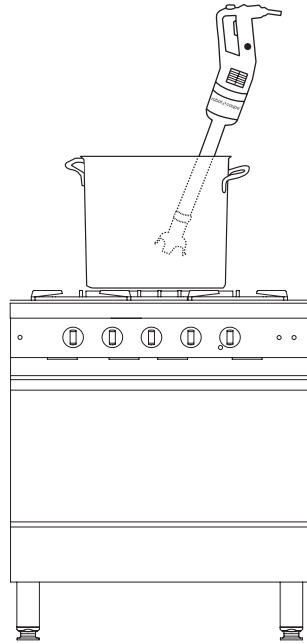
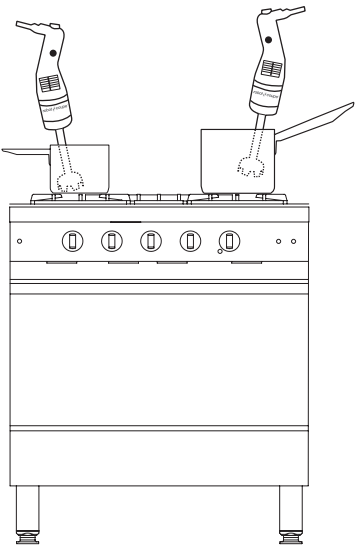





Restoranlara özel

Özel yoğun kullanım Koleksiyon Parçaları / Catering



KOMBİNE

MINI MP - CMP - MP Ultra - MP FW Ultra

 190 mm	 185 mm	 240 mm	 250 mm	 220 mm	 300 mm	 350 mm	 280 mm	 450 mm		
270 W Mini MP 190 Combi	290 W Mini MP 240 Combi		310 W CMP 250 Combi	350 W CMP 300 Combi	440 W MP 350 Combi	500 W MP 450 Combi Ultra	500 W MP 450 FW Ultra	500 W MP 450 XL FW Ultra		
			15 litre	30 litre	50 litre	100 litre	100 litre	100 litre		
Özel Küçük Karışımlar			Restoranlara özel			Özel yoğun kullanım Koleksiyon Parçaları / Catering				

TEMİZLEME

Bıçak ve çan kolaylıkla çıkarılabilir.



Tehlike Analizi ve Kritik Kontrol Noktaları (HACCP) prosedürü gereğince, kullanıcılara çanı ve bıçağı temizledikten sonra soğuk odada saklamalarını öneriyoruz.

KULLANIM RAHATLIĞI

Yorulmadan çalışmak için kullanımı kolay tencere destekleri.

1 evrensel paslanmaz çelik tencere desteği:

- Tencerenin kenarına sabitlenmelidir.

2 3 adet ayarlanabilir paslanmaz çelik tencere desteği:

- 330 ila 650 mm tencere çapı
- 500 ila 1000 mm tencere çapı
- 850 ila 1300 mm tencere çapı





Duvar askısı



MicroMix®

323 €

Güç	220 W
Voltaj	Tek fazlı 230 V
Hız	1500 ila 14000 dev/dak.
Bıçak ve boru	Uzunluk 165 mm - tamamen paslanmaz çelik
Çıkarılabilir bıçak	✓
Çıkarılabilir ayak	✓
Boyutlar	Uzunluk 430 mm, Ø 61 mm
Brüt ağırlık	1,4 kg
Aksesuarlar	Aeromix paslanmaz çelik - Dahil Duvar askısı - Dahil



Özel Merchandising Paketi

6 MicroMix'i mağazada sunmak için

	Fiyat	Ref.	Ambalajlı
Micromix 230/50/1	323 €	34900	1
6 Micromix Paketi 230/50/1	315 €	34950	6





Mini MP 160 V.V.

Güç	240 W	379 €
Voltaj	Tek fazlı 230 V	
Hız	2000 - 12500 dev/dak.	
Bıçak, çan ve boru	Uzunluk 160 mm - tamamen paslanmaz çelik	
Çıkarılabilir bıçak	✓	
Çıkarılabilir çan	Hayır	
Çıkarılabilir ayak	✓	
Boyutlar	Uzunluk 455 mm, Ø 78 mm	
Brüt ağırlık	2,4 kg	
Aksesuarlar	Aeromix paslanmaz çelik - Dahil Paslanmaz çelik duvar askısı Dahil	

Mini MP 190 V.V.

Güç	270 W	474 €
Voltaj	Tek fazlı 230 V	
Hız	2000 - 12500 dev/dak.	
Bıçak, çan ve boru	Uzunluk 190 mm - tamamen paslanmaz çelik	
Çıkarılabilir bıçak	✓	
Çıkarılabilir çan	✓	
Çıkarılabilir ayak	✓	
Boyutlar	Uzunluk 485 mm, Ø 78 mm	
Brüt ağırlık	2,5 kg	
Aksesuarlar	Aeromix paslanmaz çelik - Dahil Paslanmaz çelik duvar askısı Dahil	

Mini MP 240 V.V.

Güç	290 W	519 €
Voltaj	Tek fazlı 230 V	
Hız	2000 - 12500 dev/dak.	
Bıçak, çan ve boru	Uzunluk 240 mm - tamamen paslanmaz çelik	
Çıkarılabilir bıçak	✓	
Çıkarılabilir çan	✓	
Çıkarılabilir ayak	✓	
Boyutlar	Uzunluk 535 mm, Ø 78 mm	
Brüt ağırlık	2,5 kg	
Aksesuarlar	Aeromix paslanmaz çelik - Dahil Paslanmaz çelik duvar askısı - Dahil	

Modelinizi seçin:

Mini MP 160 V.V.	Fiyat	Ref.
Mini MP 160 V.V. 230V/50/1	379 €	34740

Mini MP 190 V.V.	Fiyat	Ref.
Mini MP 190 V.V. 230V/50/1	474 €	34750

Mini MP 240 V.V.	Fiyat	Ref.
Mini MP 240 V.V. 230V/50/1	519 €	34760



Çırpma fonksiyonu
Mini MP 190 Combi



Çırpma fonksiyonu
Mini MP 240 Combi



Duvar askısı



Duvar askısı



Duvar askısı

CMP 250 V.V.

Güç	310 W	613 €
Voltaj	Tek fazlı 230 V	
Hız	2300 ila 9600 dev/dak. kendinden ayarlı	
Bıçak, çan ve boru	Uzunluk 250 mm - tamamen paslanmaz çelik	
Çıkarılabilir bıçak	✓	
Çıkarılabilir çan	✓	
Çıkarılabilir ayak	Hayır	
Boyutlar	Uzunluk 650 mm, Ø 94 mm	
Brüt ağırlık	3,9 kg	
Aksesuarlar	Paslanmaz çelik duvar askısı Dahil	

CMP 300 V.V.

Güç	350 W	677 €
Voltaj	Tek fazlı 230 V	
Hız	2300 ila 9600 dev/dak. kendinden ayarlı	
Bıçak, çan ve boru	Uzunluk 300 mm - tamamen paslanmaz çelik	
Çıkarılabilir bıçak	✓	
Çıkarılabilir çan	✓	
Çıkarılabilir ayak	Hayır	
Boyutlar	Uzunluk 660 mm, Ø 94 mm	
Brüt ağırlık	3,9 kg	
Aksesuarlar	Paslanmaz çelik duvar askısı Dahil	

CMP 350 V.V.

Güç	400 W	721 €
Voltaj	Tek fazlı 230 V	
Hız	2300 ila 9600 dev/dak. kendinden ayarlı	
Bıçak, çan ve boru	Uzunluk 350 mm - tamamen paslanmaz çelik	
Çıkarılabilir bıçak	✓	
Çıkarılabilir çan	✓	
Çıkarılabilir ayak	Hayır	
Boyutlar	Uzunluk 700 mm, Ø 94 mm	
Brüt ağırlık	4,1 kg	
Aksesuarlar	Paslanmaz çelik duvar askısı Dahil	

Modelinizi seçin:

CMP 250 V.V.	Fiyat	Ref.
CMP 250 V.V. 230V/50/1	613 €	34240B

CMP 300 V.V.	Fiyat	Ref.
CMP 300 V.V. 230V/50/1	677 €	34230B

CMP 350 V.V.	Fiyat	Ref.
CMP 350 V.V. 230V/50/1	721 €	34250B



Çırpma fonksiyonu
CMP 250 Combi



Çırpma fonksiyonu
CMP 300 Combi

MP/CMP TENCERE DESTEKLERİ

Tencere destekleri MSD risklerini azaltır, kullanıcıların çalışmasını kolaylaştırır ve karışım üzerindeki kontrolü artırır.

Mikseri zahmetsizce eğmenize veya tutmak zorunda kalmadan çalıştırmanıza olanak tanır. Tamamen paslanmaz çelik ve tamamen çıkarılabilir destekler, kolay temizlenir ve çok pratiktir.



1 Evrensel tencere desteği:

Tüm tencere çaplarına kolayca uyum sağlar.



2 Ayarlanabilir tencere destekleri:

İsteğe bağlı olarak üç tencere desteği sunulur. Tencerenin boyuna göre ayarlanabilirler:

- Ø 330 mm'den 650 mm'ye kadar tencere.
- Ø 500 mm'den 1000 mm'ye kadar tencere.
- Ø 850 mm'den 1300 mm'ye kadar tencere.

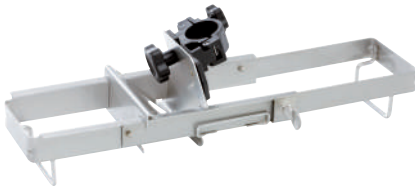

Paslanmaz Çelik Tencere Destekleri

1 evrensel paslanmaz çelik tencere desteği 1	Ref.
Tencerenin kenarına sabitlenmelidir	27358
3 ayarlanabilir paslanmaz çelik tencere desteği 2	Ref.
Çapı 330 ila 650 mm olan tencereler için	27363
Çapı 500 ila 1000 mm olan tencereler için	27364
Çapı 850 ila 1300 mm olan tencereler için	27365





Duvar askısı



Duvar askısı

MP 350 Ultra

727 €

Güç	440 W
Voltaj	Tek fazlı 230 V
Hız	9500 dev/dak.
Bıçak, çan, boru	Uzunluk 350 mm - Tamamen paslanmaz çelik
Çıkarılabilir bıçak	✓
Çıkarılabilir çan	✓
Çıkarılabilir ayak	Hayır
Easy Plug	✓
Boyutlar	Uzunluk 740 mm, Ø 125 mm
Brüt ağırlık	6,2 kg
Aksesuarlar	Paslanmaz çelik duvar askısı - Dahil

MP 350 Ultra V.V.

797 €

Güç	440 W
Voltaj	Tek fazlı 230 V
Hız	1500 ila 9000 dev/dak. kendinden ayarlı
Bıçak, çan, boru	Uzunluk 350 mm - Tamamen paslanmaz çelik
Çıkarılabilir bıçak	✓
Çıkarılabilir çan	✓
Çıkarılabilir ayak	Hayır
Easy Plug	✓
Boyutlar	Uzunluk 740 mm, Ø 125 mm
Brüt ağırlık	6,4 kg
Aksesuarlar	Paslanmaz çelik duvar askısı - Dahil

Modelinizi seçin:

MP 350 Ultra	Fiyat	Ref.
MP 350 Ultra 230V/50/1	727 €	34800L

MP 350 Ultra V.V.	Fiyat	Ref.
MP 350 V.V. Ultra 230V/50/1	797 €	34840L



Çırpma fonksiyonu

MP 350 Combi Ultra



MP 450 Ultra

803 €

Güç	500 W
Voltaj	Tek fazlı 230 V
Hız	9500 dev/dak.
Bıçak, çan, boru	Uzunluk 450 mm - Tamamen paslanmaz çelik
Çıkarılabilir bıçak	✓
Çıkarılabilir çan	✓
Çıkarılabilir ayak	Hayır
Easy Plug	✓
Boyutlar	Uzunluk 840 mm, Ø 125 mm
Brüt ağırlık	6,3 kg
Aksesuarlar	Paslanmaz çelik duvar askısı - Dahil



MP 450 Ultra V.V.

873 €

Güç	500 W
Voltaj	Tek fazlı 230 V
Hız	1500 ila 9000 dev/dak. kendinden ayarlı
Bıçak, çan, boru	Uzunluk 450 mm - Tamamen paslanmaz çelik
Çıkarılabilir bıçak	✓
Çıkarılabilir çan	✓
Çıkarılabilir ayak	Hayır
Easy Plug	✓
Boyutlar	Uzunluk 840 mm, Ø 125 mm
Brüt ağırlık	6,5 kg
Aksesuarlar	Paslanmaz çelik duvar askısı - Dahil

Modelinizi seçin:

MP 450 Ultra	Fiyat	Ref.
MP 450 Ultra 230V/50/1	803 €	34810L

MP 450 Ultra V.V.	Fiyat	Ref.
MP 450 V.V. Ultra 230V/50/1	873 €	34850L



Çırpma fonksiyonu

MP 450 Combi Ultra

EL MİKSERLERİ



Duvar askısı

MP 550 Ultra

Güç	750 W	1.201 €
Voltaj	Tek fazlı 230 V	
Hız	9000 dev/dak.	
Bıçak, çan, boru	Uzunluk 550 mm - Tamamen paslanmaz çelik	
Çıkarılabilir bıçak	✓	
Çıkarılabilir çan	✓	
Çıkarılabilir ayak	Hayır	
Çift saplı	Hayır	

Elektronik hidrofor sistemi	Hayır	
Easy Plug	✓	
Boyutlar	Uzunluk 940 mm, Ø 125 mm	
Brüt ağırlık	6,6 kg	
Aksesuarlar	Paslanmaz çelik duvar askısı Dahil	

Modelinizi seçin:

MP 550 Ultra	Fiyat	Ref.
MP 550 Ultra 230V/50/1	1.201 €	34820L



Duvar askısı

MP 600 Ultra

Güç	850 W	1.505 €
Voltaj	Tek fazlı 230 V	
Hız	9500 dev/dak.	
Bıçak, çan, boru	Uzunluk 600 mm - Tamamen paslanmaz çelik	
Çıkarılabilir bıçak	✓	
Çıkarılabilir çan	✓	
Çıkarılabilir ayak	Hayır	
Çift saplı	Hayır	

Elektronik hidrofor sistemi	Hayır	
Easy Plug	✓	
Boyutlar	Uzunluk 980 mm, Ø 125 mm	
Brüt ağırlık	7,4 kg	
Aksesuarlar	Paslanmaz çelik duvar askısı Dahil	

MP 600 Ultra	Fiyat	Ref.
MP 600 Ultra 230V/50/1	1.505 €	34830L



Duvar askısı

MP 800 Turbo

Güç	1000 W	1.688 €
Voltaj	Tek fazlı 230 V	
Hız	9500 dev/dak.	
Bıçak, çan, boru	Uzunluk 740 mm - Tamamen paslanmaz çelik	
Çıkarılabilir bıçak	✓	
Çıkarılabilir çan	✓	
Çıkarılabilir ayak	Hayır	
Çift saplı	Hayır	

Elektronik hidrofor sistemi	Hayır	
Easy Plug	✓	
Boyutlar	Uzunluk 1130 mm, Ø 125 mm	
Brüt ağırlık	9,2 kg	
Aksesuarlar	Paslanmaz çelik duvar askısı Dahil	

MP 800 Turbo	Fiyat	Ref.
MP 800 Turbo 230V/50/1	1.688 €	34890L

Paslanmaz Çelik Tencere Destekleri

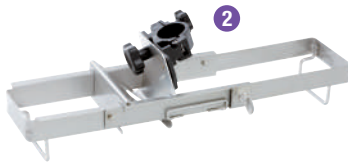

1 evrensel paslanmaz çelik tencere desteği 1	Ref.
Tencerenin kenarına sabitlenmelidir	27358
3 ayarlanabilir paslanmaz çelik tencere desteği 2	Ref.
Çapı 330 ila 650 mm olan tencereler için	27363
Çapı 500 ila 1000 mm olan tencereler için	27364
Çapı 850 ila 1300 mm olan tencereler için	27365

EL MİKSERLERİ



Mini MP 190 Combi

683 €

Mini MP 240 Combi

752 €

Güç	270 W
Voltaj	Tek fazlı 230 V
Hız	Mikserde 2000 ila 12500 dev/dak. Çırpıda 350 ila 1560 dev/dak.
Bıçak, çan, boru	Uzunluk 190 mm - Tamamen paslanmaz çelik
Çıkarılabilir bıçak	✓
Çıkarılabilir çan	✓
Çıkarılabilir ayak	✓
Metal çırpıcı kutusu	✓
Boyutlar	Toplam uzunluk: boruyla 485 mm çırpıcıyla 550 mm, Ø 78 mm
Brüt ağırlık	2,7 kg
Aksesuarlar	Paslanmaz çelik duvar askısı - Dahil

Güç	290 W
Voltaj	Tek fazlı 230 V
Hız	Mikserde 2000 ila 12500 dev/dak. Çırpıda 350 ila 1560 dev/dak.
Bıçak, çan, boru	Uzunluk 240 mm - Tamame paslanmaz çelik
Çıkarılabilir bıçak	✓
Çıkarılabilir çan	✓
Çıkarılabilir ayak	✓
Metal çırpıcı kutusu	✓
Boyutlar	Toplam uzunluk: boruyla 535 mm çırpıcıyla 550 mm, Ø 78 mm
Brüt ağırlık	2,8 kg
Aksesuarlar	Paslanmaz çelik duvar askısı - Dahil

Modelinizi seçin:

Mini MP 190 Combi	Fiyat	Ref.
Mini MP 190 Combi 230V/50/1	683 €	34770

Mini MP 240 Combi	Fiyat	Ref.
Mini MP 240 Combi 230V/50/1	752 €	34780

İsteğe bağlı parçaları seçin:

	Mini MP 190 Combi
İsteğe bağlı parça	Ref.
Mini MP çırpıcı aksesuarı	27333

	Mini MP 240 Combi
İsteğe bağlı parça	Ref.
Mini MP çırpıcı aksesuarı	27333



CMP 250 Combi

910 €

Güç	310 W
Voltaj	Tek fazlı 230 V
Hız	Mikserde 2300 ila 9600 dev/dak. kendinden ayarlı çırpıcıda 500 ila 1800 dev/dak.
Bıçak, çan, boru	Uzunluk 250 mm - Tamamen paslanmaz çelik
Çıkarılabilir bıçak	✓
Çıkarılabilir çan	✓
Çıkarılabilir ayak	✓ 3 seviyeli sızdırmazlık sistemiyle donatılmıştır
Metal çırpıcı kutusu	✓
Boyutlar	Toplam uzunluk: boruyla 640 mm çırpıcıyla 610 mm, Ø 125 mm
Brüt ağırlık	5,6 kg
Aksesuarlar	Paslanmaz çelik duvar askısı - Dahil

CMP 300 Combi

949 €

Güç	350 W
Voltaj	Tek fazlı 230 V
Hız	Mikserde 2300 ila 9600 dev/dak. kendinden ayarlı çırpıcıda 500 ila 1800 dev/dak.
Bıçak, çan, boru	Uzunluk 300 mm - Tamamen paslanmaz çelik
Çıkarılabilir bıçak	✓
Çıkarılabilir çan	✓
Çıkarılabilir ayak	✓ 3 seviyeli sızdırmazlık sistemiyle donatılmıştır
Metal çırpıcı kutusu	✓
Boyutlar	Toplam uzunluk: boruyla 700 mm çırpıcıyla 610 mm, Ø 125 mm
Brüt ağırlık	5,7 kg
Aksesuarlar	Paslanmaz çelik duvar askısı - Dahil

Modelinizi seçin:

CMP 250 Combi	Fiyat	Ref.
CMP 250 Combi 230V/50/1	910 €	34300B

CMP 300 Combi	Fiyat	Ref.
CMP 300 Combi 230V/50/1	949 €	34310B

İsteğe bağlı parçaları seçin:

	CMP 250 Combi
İsteğe bağlı parçalar	Ref.
CMP Combi çırpıcı aksesuarı	27248
Mikser ayağı	27249

	CMP 300 Combi
İsteğe bağlı parçalar	Ref.
CMP Combi çırpıcı aksesuarı	27248
Mikser ayağı	27250

EL MİKSERLERİ



Duvar askısı



Duvar askısı



MP 350 Combi Ultra

1.124 €

Güç	440 W
Voltaj	Tek fazlı 230 V
Hız	Mikserde 1500 ila 9000 dev/dak. kendinden ayarlı çirpicide 250 ila 1500 dev/dak.
Bıçak, çan, boru	Uzunluk 350 mm - Tamamen paslanmaz çelik
Çıkarılabilir bıçak	✓
Çıkarılabilir çan	✓
Çıkarılabilir ayak	✓
Metal çirpici kutusu	✓
Çıkarılabilir çirpici	✓
Easy Plug	✓
Boyutlar	Toplam uzunluk: boruyla 790 mm çirpiciyle: 805 mm, Ø 125 mm
Brüt ağırlık	7,9 kg
Aksesuarlar	Paslanmaz çelik duvar askısı - Dahil

MP 450 Combi Ultra

1.216 €

Güç	500 W
Voltaj	Tek fazlı 230 V
Hız	Mikserde 1500 ila 9000 dev/dak. kendinden ayarlı çirpicide 250 ila 1500 dev/dak.
Bıçak, çan, boru	Uzunluk 450 mm - Tamamen paslanmaz çelik
Çıkarılabilir bıçak	✓
Çıkarılabilir çan	✓
Çıkarılabilir ayak	✓
Metal çirpici kutusu	✓
Çıkarılabilir çirpici	✓
Easy Plug	✓
Boyutlar	Toplam uzunluk: boruyla 890 mm çirpiciyle 840 mm, Ø 125 mm
Brüt ağırlık	8,2 kg
Aksesuarlar	Paslanmaz çelik duvar askısı - Dahil

Modelinizi seçin:

MP 350 Combi Ultra	Fiyat	Ref.
MP 350 Combi Ultra 230V/50/1	1.124 €	34860L

MP 450 Combi Ultra	Fiyat	Ref.
MP 450 Combi Ultra 230V/50/1	1.216 €	34870L

İsteğe bağlı parçaları seçin:

İsteğe bağlı parçalar	Ref.
CMP Kombi çirpici aksesuarı	27210
Mikser alet aksesuarı	27355
Mikser ayağı	39354

MP 350 Combi Ultra

MP 450 Combi Ultra

Ref.
27210
27355
39355

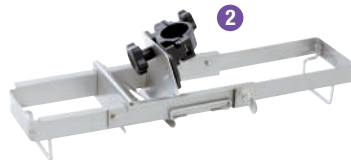

Paslanmaz Çelik Tencere Destekleri

1 evrensel paslanmaz çelik tencere desteği 1	Ref.
Tencerenin kenarına sabitlenmelidir	27358
3 ayarlanabilir paslanmaz çelik tencere desteği 2	Ref.
Çapı 330 ila 650 mm olan tencereler için	27363
Çapı 500 ila 1000 mm olan tencereler için	27364
Çapı 850 ila 1300 mm olan tencereler için	27365



Duvar askısı



MP 450 FW Ultra

967 €

Güç	500 W
Voltaj	Tek fazlı 230 V
Hız	250 ila 1500 dev/dak kendinden ayarlı
Çırpıcı	280 mm uzunluğunda çıkarılabilir çırpıcı
Metal çırpıcı kutusu	✓
Easy Plug	✓
Boyutlar	Uzunluk 800 mm, Ø 125 mm
Brüt ağırlık	8,6 kg
Aksesuarlar	Paslanmaz çelik duvar askısı Dahil



Duvar askısı



MP 450 XL FW Ultra

1.235 €

Güç	500 W
Voltaj	Tek fazlı 230 V
Hız	150-510 dev/dak. kendinden ayarlı
Çıkarılabilir karıştırıcı alet	690 mm uzunluğunda
Metal çırpıcı kutusu	✓
Easy Plug	✓
Boyutlar	Uzunluk 1210 mm, Ø 175 mm
Brüt ağırlık	8,6 kg
Aksesuarlar	Paslanmaz çelik duvar askısı Dahil

Modelinizi seçin:

MP 450 FW Ultra	Fiyat	Ref.
MP 450 FW Ultra 230V/50/1	967 €	34880L

MP 450 XL FW Ultra	Fiyat	Ref.
MP 450 XL FW Ultra 230V/50/1	1.235 €	34280L

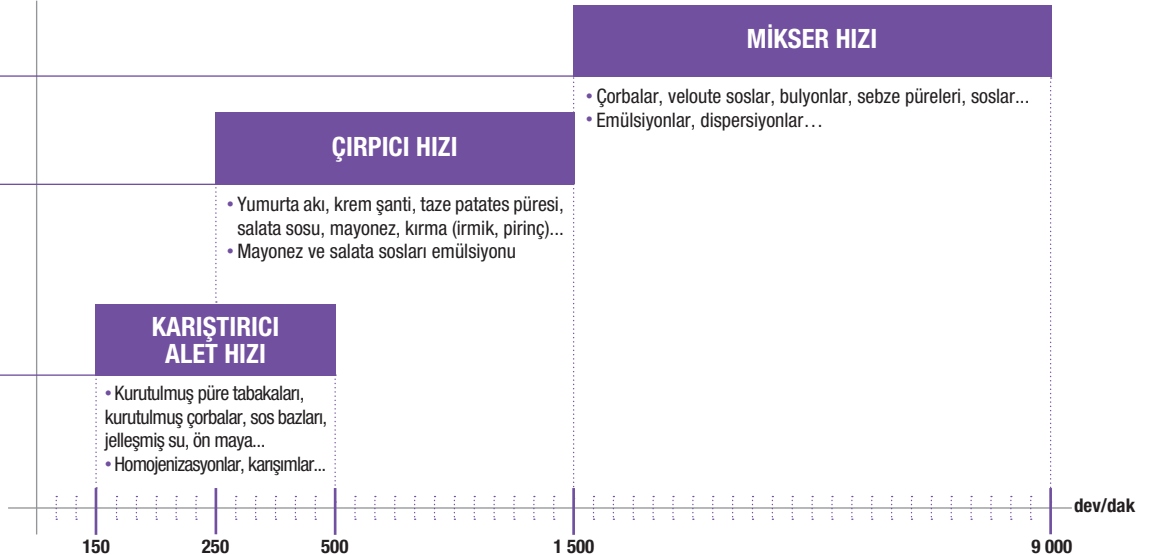

KATI MEYVE SIKACAKLARI

OTOMATİK



KATI MEYVE SIKACAKLARI



J 80 2.160 €

Asenkron motor	✓
Güç	700 W
Voltaj	Tek fazlı 230 V
Debi	120 L/sa.
Hazne	Paslanmaz çelik
Oluk	✓ - Otomatik Ø 79 mm
Filtre	Paslanmaz çelik
Rende diski	Paslanmaz çelik
Oluk ağız altı faydalı yükseklik	155 mm
SERVİS: Bardak	✓
Sürahi	✓
Blender haznesi	-
Sıçrama korumalı oluk ağız	✓ - 1 boy
Eğimli taban	✓
Damlama tepsisi	✓
Otomatik atık çıkarma	✓
Yarı saydam atık tablası	6,5 L
Sürekli atık tahliye haznesi	-

YENİ

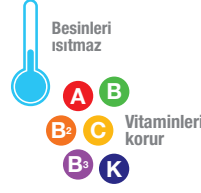

J 80 Buffet 2.320 €

Asenkron motor	✓
Güç	700 W
Voltaj	Tek fazlı 230 V
Debi	120 L/sa.
Hazne	Paslanmaz çelik
Oluk	✓ - Otomatik Ø 79 mm
Filtre	Paslanmaz çelik
Rende diski	Paslanmaz çelik
Oluk ağız altı faydalı yükseklik	177 mm
SERVİS: Bardak	✓
Sürahi	✓
Blender haznesi	-
Sıçrama korumalı oluk ağız	✓ - 2 boy
Eğimli taban	✓
Damlama tepsisi	✓ - Büyük kapasite
Otomatik atık çıkarma	✓
Yarı saydam atık tablası	6,5 L
Sürekli atık tahliye haznesi	-

Modelinizi seçin:

J 80	Fiyat	Ref.
J 80 230V/50/1	2.160 €	56000B

J 80 Buffet	Fiyat	Ref.
J 80 Buffet 230V/50/1	2.320 €	56200B



Katı Meyve Sıkacağına çalışırken görmek için bu QR-Kodunu tarayın.

İsteğe bağlı parçaları seçin:

Aksesuarlar	Ref.
Taban kiti + XL damlama tepsisi + uzun ağız	49230

J 80 tüm modeller



J 100 2.781 €

Asenkron motor	✓
Güç	1000 W
Voltaj	Tek fazlı 230 V
Debi	160 L/sa.
Hazne	Paslanmaz çelik
Oluk	✓ - Otomatik Ø 79 mm
Filtre	Paslanmaz çelik
Rende disk	Paslanmaz çelik - yoğun kullanım için özel
Oluk ağız altı faydalı yükseklik	251 mm
SERVİS: Bardak	✓
Sürahi	✓
Blender haznesi	✓
Sıçrama korumalı oluk ağız	✓ - 2 boy
Eğimli taban	✓
Damlama tepsisi	✓
Otomatik atık çıkarma	✓
Yarı saydam atık tablası	7,2 L
Sürekli atık tahliye haznesi	✓

Modelinizi seçin:	J 100	Fiyat	Ref.
	J 100 230V/50/1	2.781 €	56100B

İsteğe bağlı parçaları seçin:

Aksesuarlar	J 100	Ref.
Taban kiti + XL damlama tepsisi + uzun ağız		49230

MEYVE/SEBZE SUYU SIKMA VE PÜRE KİTİ

- Posa açısından zengin sebze ve meyvelerin suyunu çıkarır.
- Küçük miktarlarda pişmiş ve yumuşak sebze ve meyvelerin püresini çıkarır.
- Kabuğu, tohumları ve lifleri tutar.



C 40 940 €

Asenkron motor	✓
Güç	500 W
Voltaj	Tek fazlı 230 V
Hız	1500 dev/dak.
Debi	12 L/sa.
Hazne	Kompozit malzemeler

Modelinizi seçin:

C 40	Fiyat	Ref.
C 40 230V/50/1	940 €	55040

Gazpaço, domates sosu, et ve balık için marinatlar, smoothie içecekler, meyve püreleri, sorbeler ve dondurma...



Gazpaço ve soslar için yoğun domates suyu.



İçecekler, sorbeler ve marinatlar için limon suyu.



TEKNİK VERİLER

ROBOT-COOK®					Boyut (mm)			Ağırlık (kg)	
Adı	Ref.	Güç (w)	Tek fazlı	Üç fazlı	Uzunluk	Derinlik	Yükseklik	Net	Brüt
Robot Cook 230V/50-60/1	43000R	1 800	•		225	340	520	14	14

BLIXER®					Boyut (mm)			Ağırlık (kg)	
Adı	Ref.	Güç (w)	Tek fazlı	Üç fazlı	Uzunluk	Derinlik	Yükseklik	Net	Brüt
Blixer 3 230V/50/1	33197	750	•		240	305	445	12	13
Blixer 4 - 1V 230V/50/1	33208	900	•		240	330	480	14	15
Blixer 4 - 2V 400V/50/3	33215	1 000		•	240	305	445	14	15
Blixer 4 V.V. 230V/50-60/1	33280	1 100	•		240	330	480	16	17
Blixer 5 - 2V 400V/50/3	33164	1 300		•	280	350	500	21	24
Blixer 5 V.V. 230V/50-60/1	33171	1 400	•		280	350	500	22	25

EL MİKSERLERİ					Boyut (mm)		Ağırlık (kg)	
Adı	Ref.	Güç (w)	Tek fazlı	Üç fazlı	Ø	Yükseklik	Net	Brüt
MicroMix 230/50/1	34900	220	•		61	430	1	1
Mini MP 160 V.V. 230V/50/1	34740	240	•		78	455	1	2
Mini MP 190 V.V. 230V/50/1	34750	270	•		78	485	2	3
Mini MP 240 V.V. 230V/50/1	34760	290	•		78	535	2	3
CMP 250 V.V. 230V/50/1	34240A	310	•		94	650	3	4
CMP 300 V.V.230V/50/1	34230A	350	•		94	660	3	4
CMP 350 V.V. 230V/50/1	34250A	400	•		94	700	4	4
MP 350 Ultra 230V/50/1	34800L	440	•		125	740	5	7
MP 350 V.V. Ultra 230V/50/1	34840L	440	•		125	740	5	6
MP 450 Ultra 230V/50/1	34810L	500	•		125	840	5	6
MP 450 V.V. Ultra 230V/50/1	34850L	500	•		125	840	5	7
MP 550 Ultra 230V/50/1	34820L	750	•		125	940	5	7
MP 600 Ultra 230V/50/1	34830L	850	•		125	980	6	7
MP 800 Turbo 230V/50/1	34890L	1 000	•		125	1 130	7	9
Mini MP 190 Combi 230V/50/1	34770	270	•		78	485	2	3
Mini MP 240 Combi 230V/50/1	34780	290	•		78	535	2	3
CMP 250 Combi 230V/50/1	34300A	310	•		125	640	3	6
CMP 300 Combi 230V/50/1	34310A	350	•		125	700	3	6
MP 350 Combi Ultra 230V/50/1	34860L	440	•		125	790	6	8
MP 450 Combi Ultra 230V/50/1	34870L	500	•		125	890	6	8
MP 450 FW Ultra 230V/50/1	34880L	500	•		125	800	6	9
MP 450 XL FW Ultra 230V/50/1	34280L	500	•		175	1 210	5	9

KATI MEYVE SIKACAKLARI					Boyut (mm)			Ağırlık (kg)	
Adı	Ref.	Güç (w)	Tek fazlı	Üç fazlı	Uzunluk	Derinlik	Yükseklik	Net	Brüt
J 80 230V/50/1	56000B	700	•		235	535	500	11	13
J 80 Buffet 230V/50/1	56200B	700	•		260	565	595	11	13
J 100 230V/50/1	56100B	1 000	•		260	565	630	14	15
C 40 230V/50/1	55040	500	•		240	280	645	10	11

TEKNİK VERİLER

KOMBİNELER

Boyut (mm)

Ağırlık (kg)

Adı	Ref.	Güç (w)	Tek fazlı	Üç fazlı	Uzunluk	Derinlik	Yükseklik	Net	Brüt
R 201 XL 230V/50/1	22570	550	•		220	280	555	10	11
R 211 XL 230V/50/1	2129	550	•		220	360	505	13	14
R 301 230V/50/1	2525	650	•		355	305	570	20	22
R 301 Ultra 230V/50/1	2547	650	•		355	305	570	19	20
R 402 230V/50/1	2453	750	•		320	305	590	21	23
R 402 400V/50/3	2433	750		•	320	305	590	22	24
R 502 400V/50/3	2483	1 000		•	380	350	660	18	33
R 652 V.V. 230V/50/1	2138	1 500	•	•	380	350	700	24	40

SEBZE DOĞRAMA

Boyut (mm)

Ağırlık (kg)

Adı	Ref.	Güç (w)	Tek fazlı	Üç fazlı	Uzunluk	Derinlik	Yükseklik	Net	Brüt
CL 20 230V/50/1	22394	400	•		325	310	570	21	24
CL 30 Bistro 230V/50/1	24432	500	•		345	330	590	14	15
CL 50 - 1V 230V/50/1	24440	550	•		380	305	595	18	20
CL 50 Ultra - 1V 230V/50/1	24465	550	•		380	305	595	18	20
CL 50 Ultra Pizza 230V/50/1	2027	550	•		380	305	595	18	20
CL 50 Gourmet 230V/50/1	24453	550	•		390	340	610	20	22
CL 52 - 1V 230V/50/1	24490	750	•		360	340	690	26	28
CL 55 İtme Kafalı 230V/50/1	2245	750	•		700	359	1 100	35	54
CL 55 İtme Kafalı 400V/50/3	2214	1 100		•	700	359	1 100	35	54
CL 55 2 Kafalı 230V/50/1	2244	750	•		865	396	1 270	42	61
CL 55 2 Kafalı 400V/50/3	2211	1 100		•	865	396	1 270	42	61
CL 60 İtme Kafalı 400V/50/3	2319	1 500		•	335	560	1 160	57	83
CL 60 2 Kafalı 400V/50/3	2325	1 500		•	460	770	1 355	69	95

PARÇALAYICILAR

Boyut (mm)

Ağırlık (kg)

Adı	Ref.	Güç (w)	Tek fazlı	Üç fazlı	Uzunluk	Derinlik	Yükseklik	Net	Brüt
R 2 230V/50/1	22100	550	•		200	280	350	9	11
R 3 230V/50/1	22382	650	•		210	320	400	10	11
R 4 - 2V 400/50/3	22437	900		•	225	305	440	17	18
R 4 -1V 230V/50/1	22430	700	•		225	305	440	13	14
R 5 - 1V 230V/50/1	24323	1 100	•		280	350	490	22	24
R 5 - 2V 400V/50/3	24309	1 200		•	280	350	490	22	24
R 6 V.V. 230/50-60/1	24304	1 500		•	280	350	520	23	25
R 8 400V/50/3	21291	2 200		•	315	545	585	37	45
R 15 400V/50/3	51491	3 000		•	370	615	680	50	59
R 20 400V/50/3	51591	4 400		•	380	630	760	77	86
R 23 400V/50/3	51331C	4 500		•	700	600	1 250	110	142
R 30 400V/50/3	52331C	5 400		•	720	600	1 250	126	148
R 45 400V/50/3	53331C	10 000		•	760	600	1 400	172	195
R 60 400V/50/3	54331C	11 000		•	810	600	1 400	187	212

Notlar

A series of horizontal dotted lines for writing notes.